

MADE IN ITALY. MADE TO EXCEL.

NORDE



atlas concorde

March 2021



STONE LOOK

NORDE

Porcelain tiles

Index

Overview



Spaces

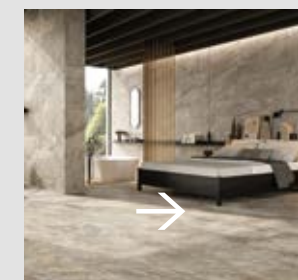
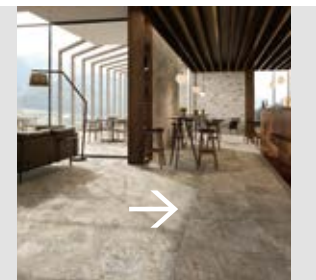
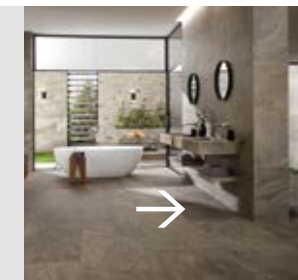
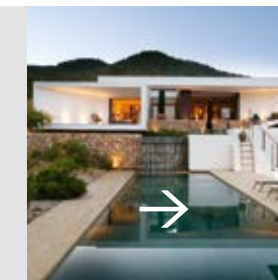

Product Range



Technical Specifications



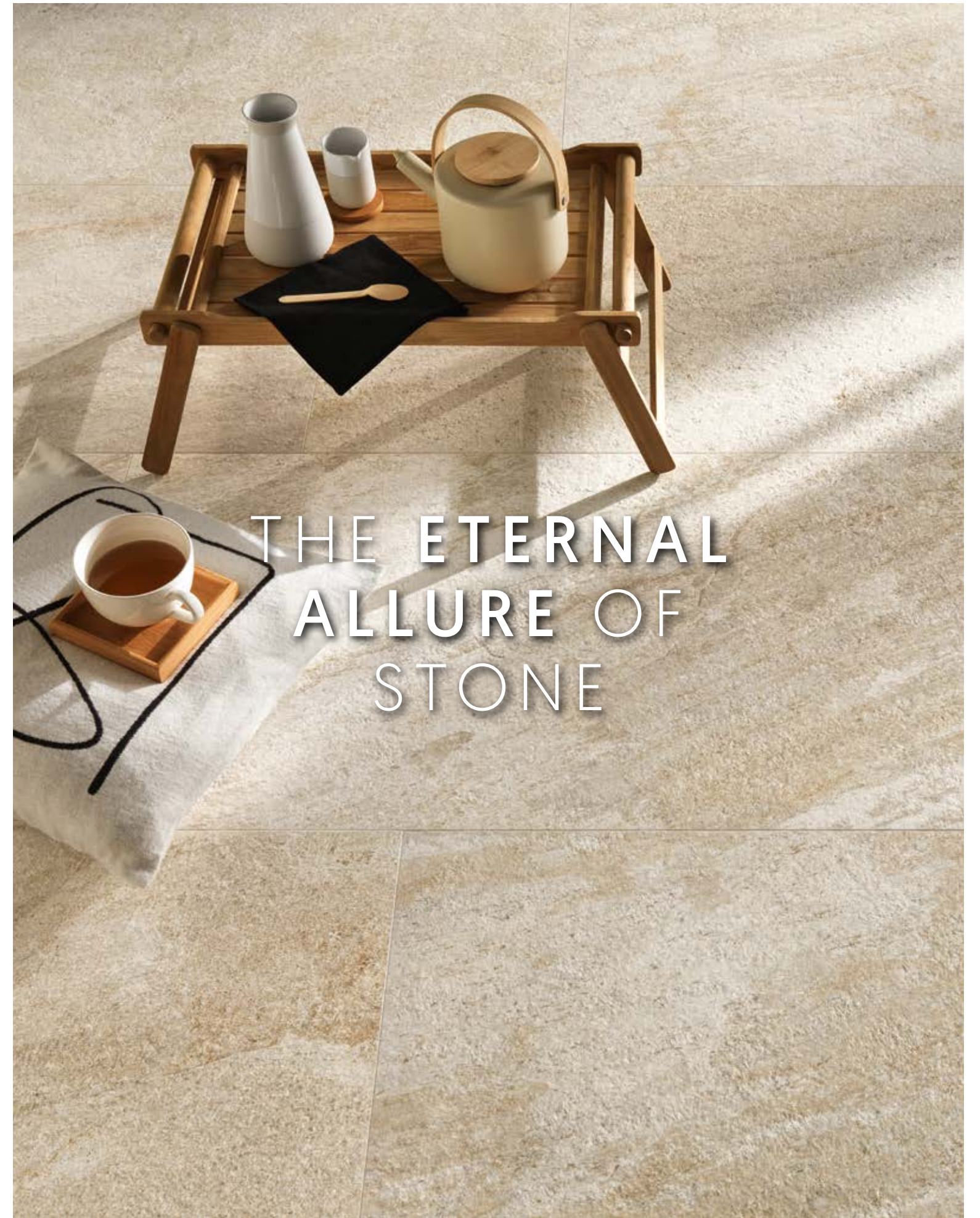

THE ETERNAL
ALLURE OF
STONE

CERAMIC AND PORCELAIN TILES: A SAFE CHOICE

● **IT DOES NOT BURN**
Non brucia

● **RECYCLABLE**
Riciclabile

● **HYGIENIC**
Igienico

● **VERSATILE**
Versatile

● **IT LOVES THE ENVIRONMENT**
Ama l'ambiente

● **LONG LASTING**
Dura a lungo

● **SAFE**
Sicuro

● **RESISTANT**
Resistente

● **ZERO PVC**
Zero PVC

● **ZERO VOCS**
Zero VOC

THE KEY TO INDOOR AND OUTDOOR DESIGN_

Norde is inspired by quartzites, metamorphic stones composed almost entirely of quartz and small quantities of other minerals that create color changes and nuances. Such stones are typically suitable for the outdoors but can also be used indoors.

Norde è ispirata alle quarziti, pietre metamorfiche composte quasi interamente di quarzo e piccole quantità di altri minerali che ne determinano variazioni cromatiche e sfumature. Pietre tipicamente adatte all'uso outdoor ma anche nell'indoor.



Norde s'inspire des quartzites, pierres métamorphiques composées presque entièrement de quartz et de petites quantités d'autres minéraux qui en déterminent les nuances et les variations chromatiques. Ces pierres sont typiquement adaptées à l'usage d'extérieur mais aussi en intérieur.

Norde ist an den Quarziten inspiriert. Es handelt sich um metamorphe Gesteine, die beinahe vollständig aus Quarz und geringen Mengen anderer Minerale bestehen, welche ihre farblichen Varianten und Nuancen bestimmen. Insbesondere für den Einsatz im Outdoor, aber auch für Innenräume geeignet.

Norde se inspira en las cuarcitas, piedras metamórficas compuestas casi en su totalidad por cuarzo y pequeñas cantidades de otros minerales que determinan matices y variaciones cromáticas. Piedras típicamente aptas para exteriores, pero también para ser utilizadas en el interior.

Отправной точкой в создании коллекции Norde стали кварциты, метаморфические горные породы, состоящие в основном из кварца и небольшого количества других минералов, которые определяют их цветовые оттенки. Подходят эти камни для отделки как наружных, так и внутренних пространств.



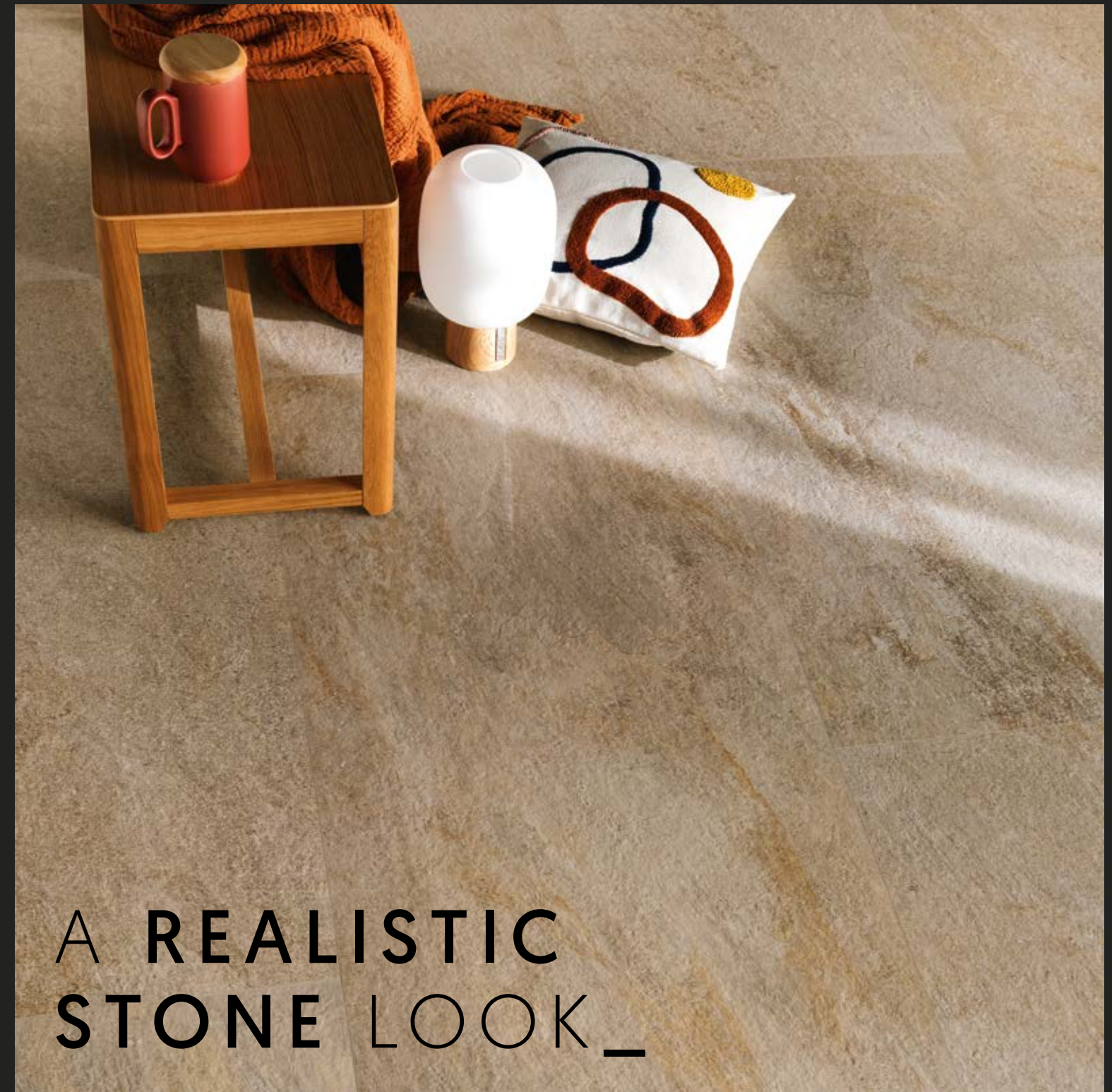

A REALISTIC STONE LOOK_

The collection has a distinctive, realistic stone look featuring detailed graphics and a rich array of colors.

Un effetto pietra distintivo e realistico distingue la collezione, caratterizzata da una grafica dettagliata e da una grande ricchezza cromatica.

Un effet pierre distinctif et réaliste caractérise la collection, qui se distingue par un graphisme très nuancé et une grande richesse chromatique.

Eine Kollektion von besonderer und naturgetreuer Steinoptik, die sich durch eine detailreiche Grafik und große chromatische Vielfalt auszeichnet.

Un efecto piedra particular y realista distingue a la colección, caracterizada por gráficos detallados y una gran riqueza de colores.

Отличительной чертой этой коллекции является удивительно реалистичный эффект камня с детально воссозданным рисунком и невероятным богатством оттенков.

Appealing hues with reddish and orange shades that immediately recall the look of rust. A refined finish for interior designs and contract work with a contemporary style.

Tonalità affascinanti con sfumature rossastre e arancioni che richiamano subito l'effetto della ruggine. Una finitura ricercata in contesti di interior design e contract di stile contemporaneo.

Des tonalités séduisantes aux nuances rougeâtres et orangées qui rappellent aussitôt l'effet de la rouille. Une finition recherchée dans des contextes de design d'intérieur au style contemporain.

Faszinierende Farbtöne mit rötlichen und orangen Nuancen lassen unmittelbar an Rost denken. Eine ausgesuchte Oberfläche für das gehobene Innendesign und für Bauobjekte in zeitgenössischem Stil.

Tonos fascinantes con sub-tonsos rojizos y anaranjados que recuerdan el efecto del óxido. Un acabado refinado en contextos de diseño de interiores y ambientes con estilo contemporáneo.

Пленительные цвета с красноватыми и оранжевыми оттенками вызывают в памяти теплый вид ржавчины. Такая отделка прекрасно подойдет для оформления в современном стиле как домашних интерьеров, так и отелей, ресторанов и т.п.





NATURAL SHADES OF BEAUTY_

MAGNESIO

ORO

PLATINO

PIOMBO



The collection comes in four colors: Magnesio, an ivory with warm inclusions; Oro, a golden, warm, and intense shade with a dominant gray sand; Platino, a bright light gray with flashes of silver; Piombo, a dark gray with tones inspired by the color of the original natural stones.

La collezione è declinata in quattro colori: Magnesio, un avorio con importanti inclusioni calde; Oro, una tonalità dorata, calda e intensa con una dominante grigio sabbia; Platino, un grigio chiaro luminoso e dai riflessi argentati; Piombo, un grigio scuro dai toni ispirati al colore delle pietre naturali di riferimento.

La collection se décline en quatre couleurs : Magnesio, un ivoire avec d'importantes inclusions aux tons chauds ; Oro, une tonalité dorée, chaude et intense avec une dominante couleur gris sable ; Platino, un gris clair lumineux et aux reflets argentés ; Piombo, un gris foncé dont les tonalités s'inspirent de la couleur des pierres naturelles de référence.

Die Kollektion umfasst vier Farbvarianten: Magnesio, Elfenbein mit prägnanten Einschlüssen in warmen Farben; Oro, ein goldener, warmer und intensiver Ton mit einer dominanten sandgrauen Note; Platino, ein helles, leuchtendes Grau mit silbrigen Reflexen; Piombo, dunkles Grau in den Nuancen der als Vorbild dienenden Natursteine.

La colección está disponible en cuatro colores: Magnesio, un marfil con importantes inclusiones cálidas; Oro, una tonalidad dorada, cálida e intensa con predominio del gris arena; Platino, un luminoso gris claro y con reflejos plateados; Piombo, un gris oscuro con tonos inspirados en el color de las piedras naturales de referencia.

Коллекция представлена в четырех цветах: Magnesio – слоновая кость с включениями теплых оттенков; Oro – теплый золотистый тон с серо-песочной доминантой; Platino – светлый серый с серебристыми отблесками; Piombo – темно-серый оттенок исходного природного образца кварцита.



**PORCELAIN TILES
FOR FLOORS AND WALLS**

60x120cm - 23⁵/₈"x47¹/₄" ±9 mm

60x60cm - 23⁵/₈"x23⁵/₈" ±9 mm

30x60cm - 11³/₄"x23⁵/₈" ±9 mm

OUTDOOR AND WET AREAS

30x60cm - 11³/₄"x23⁵/₈"w ±9 mm

60x120cm - 23⁵/₈"x47¹/₄" ±9 mm

60x120cm - 23⁵/₈"x47¹/₄" ±20 mm

60x90cm - 23⁵/₈"x35³/₈" ±20 mm

80x80cm - 31¹/₂"x31¹/₂" ±20 mm

60x60cm - 23⁵/₈"x23⁵/₈" ±20 mm

ONE PRODUCT FITS ALL_



In just one collection Norde offers a wide range of sizes, finishes, and thicknesses with superior technical performance for any type of use, indoors and out.

The modular sizes measuring 60 and 120 cm allow you to perfectly match the indoor and outdoor finishes.

Norde raccoglie in un'unica collezione una vasta gamma di formati, finiture e spessori dalle prestazioni tecniche ideali per ogni tipo di destinazione d'uso, indoor e outdoor.

I formati modulari sui lati 60 e 120 cm consentono di abbinare perfettamente le finiture da interno e da esterno.

Norde présente en une seule collection une vaste gamme de formats, de finitions et d'épaisseurs, aux performances techniques parfaites pour tous types d'utilisation, en intérieur et en extérieur.

Les formats aux côtés modulaires de 60 et 120 cm permettent d'associer parfaitement les finitions d'intérieur et d'extérieur.

Norde umfasst in einer einzigen Kollektion ein reiches Angebot aus Formaten, Oberflächen und Stärken mit technischen Leistungen, die für jeden Einsatzbereich ideal sind, in Innen- wie in Außenbereichen.

Die modularen Formate mit der Kantenlänge 60 und 120 cm erlauben eine perfekt aufeinander abgestimmte Optik im In- und Outdoorbereich.

Norde reúne en una sola colección una amplia gama de formatos, acabados y espesores con las prestaciones técnicas ideales para todo tipo de uso, tanto en interiores como en exteriores.

Los formatos modulares de 60 y 120 cm de lado permiten combinar perfectamente los acabados de interior y exterior.

Коллекция Norde объединила в себе широкую гамму форматов, толщин и поверхностей с высокими техническими характеристиками для укладки в любых контекстах – внутри помещений или на улице.

Модульность форматов по граням 60 и 120 см позволяет гармонично сочетать между собой интерьерные и уличные варианты плиток.



SURFACES TO TOUCH AND EXPERIENCE

The Roccia finish, with its characteristic three-dimensional texture, is one of the elements of the collection that truly stands out. Available in a 30x60 cm format, it is inspired by split quartzites, stones with a layered structure that, once extracted, are worked with special tools and split into slabs along the shale layers.

La finitura Roccia, con la sua struttura tridimensionale evidente e connotata, è un elemento caratteristico della collezione. Disponibile nel formato 30x60 cm si ispira alle quarziti a spacco, pietre dalla struttura stratificata che, una volta estratte, vengono lavorate con speciali utensili e si sfaldano in lastre secondo i piani di scistosità.

La finition Roccia, avec une structure tridimensionnelle marquée et connotée, est un élément caractéristique de la collection. Disponible au format 30x60 cm, elle s'inspire des quartzites de clivage, pierres à structure stratifiée qui, une fois extraites, sont usinées avec des outils particuliers et se clivent en plaques selon les plans de schistosité.

Die Oberflächenausführung Roccia mit ihrer dreidimensionalen und markanten Struktur ist ein charakteristisches Element der Kollektion. Sie ist nur im Format 30x60 cm erhältlich und verweist auf gespaltenes Quarzitgestein von geschichteter Struktur, das nach dem Abbau im Steinbruch mit Spezialwerkzeugen bearbeitet und den Schieferschichten entsprechend in Platten abgespalten wird.

El acabado Roccia, con su evidente y distintiva estructura tridimensional, es un elemento característico de la colección. Disponible en formato 30x60 cm se inspira en las cuarcitas partidas, piedras con una estructura estratificada que, una vez extraídas, se trabajan con herramientas especiales y se fragmentan en losas según los planos de esquistosidad.

Одной из характерных особенностей коллекции является поверхность Roccia с выраженной трехмерной фактурой. Доступна в формате 30x60 см и имитирует колотый кварцит – слоистый камень, который после извлечения обрабатывают специальным инструментом, раскалывая на листы по плоскостям сланцеватости.

DECORATING THE OUTDOORS_

The rich range of decors features original mosaics enriched with Corten tiles and traditional Bricks as well as a project designed for the outdoors with Palladiana decors in a grip finish and Path slabs with a 20 mm thickness, ideal for customizing walkways and outdoor spaces.

Una gamma decorativa ricca che accanto a originali mosaici arricchiti da tessere Corten e ai tradizionali Brick, presenta un progetto dedicato al design dell'outdoor con i decori Palladiana in finitura grip e Path in 20mm di spessore, ideali per personalizzare camminamenti e spazi esterni.

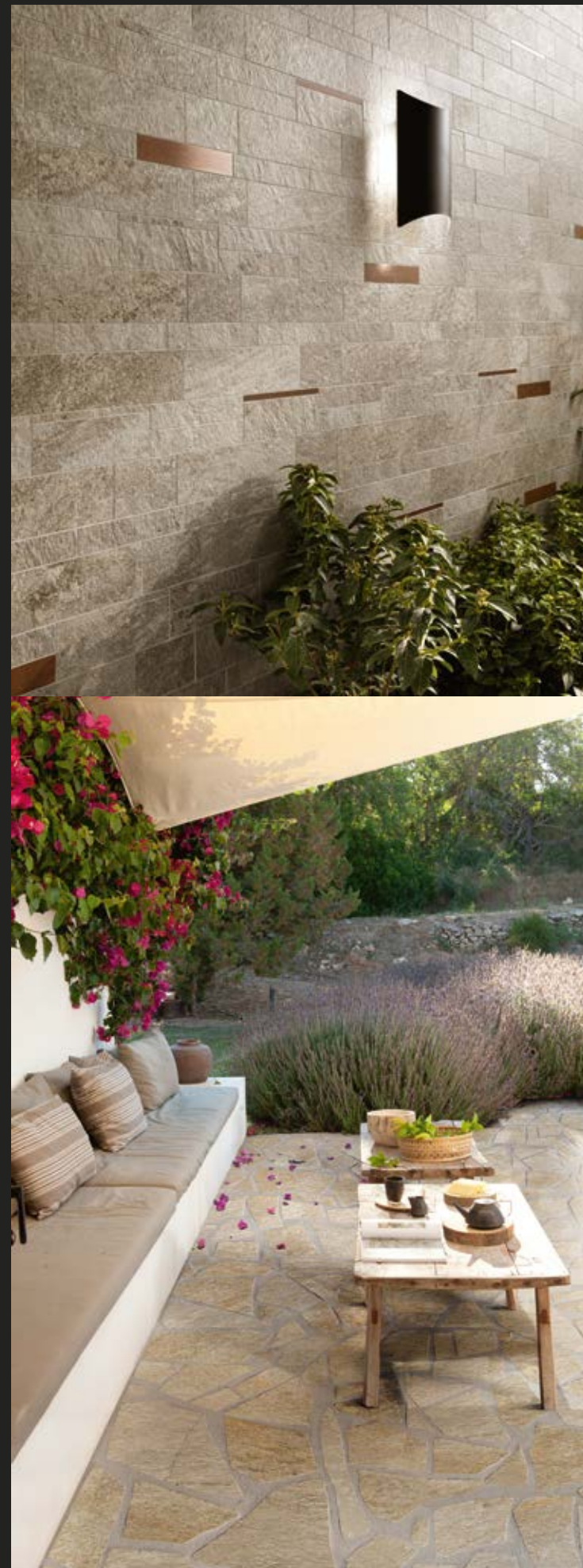

Une gamme décorative très variée, qui ensemble à d'originales mosaïques enrichies des tesselles Corten et des Brick traditionnels, présente un projet dédié au design d'extérieur avec les décors Palladiana en finition grip et Path de 20 mm d'épaisseur, idéaux pour personnaliser les allées et les espaces extérieurs.

Eine reiche Produktpalette, die neben originellen Mosaiken im Mix mit den Elementen Corten und dem traditionelleren Brick ein außergewöhnliches Outdoor-Designprojekt entstehen lässt. Dazu sind die Dekore Palladiana in der Oberflächenversion Grip und Path in 20 mm Stärke ideal für die Gestaltung von Wegen und Flächen im Freien.

Una ricca gama decorativa que, junto a los originales mosaicos enriquecidos con teselas Corten y a los tradicionales Brick, presenta un proyecto dedicado al diseño de exteriores con decoraciones Palladiana en acabado grip y Path de 20 mm de espesor, ideales para personalizar senderos y espacios exteriores.

Богатая гамма декоративных элементов, помимо оригинальной мозаики с тессерами Corten и традиционного Brick, предлагает проект для наружных пространств, который включает декоры Palladiana с противоскользящей поверхностью Grip и Path толщиной 20 мм для индивидуализации дорожек и прочих уличных зон.



A VILLA FULL OF LIGHT
WHETHER INSIDE OR OUT_ atlasconcorde



atlas concorde

CONTEMPORARY MEDITERRANEAN SOUL

A look inspired by natural stone. A palette of warm, bright colors for interiors and exteriors breathes life into fluid, evocative spaces that harmoniously interact with nature, with decorative compositions in Palladiana and Path 20 mm.

Un effetto ispirato alla pietra naturale. Una tavolozza di colori caldi e luminosi per interni ed esterni danno vita a ambienti fluidi e suggestivi che dialogano armonicamente con la natura, con interventi decorativi di composizioni a Palladiana e Path 20mm.

Un effet qui s'inspire de la pierre naturelle. La palette des couleurs chaudes et lumineuses pour l'intérieur et l'extérieur donnent naissance à des espaces fluides et suggestifs qui dialoguent harmonieusement avec la nature, avec des interventions de composition décoratives grâce à Palladiana et Path 20 mm.

Am Naturstein inspirierte Optik. Eine Palette aus warmen und leuchtenden Farben für innen und außen lassen behagliche und stimmungsvolle Bereiche entstehen, die harmonisch mit der Natur dialogieren. Dazu die dekorativen Kompositionen Palladiana und Path 20 mm.

Un efecto inspirado en la piedra natural. Una paleta de colores cálidos y brillantes para interiores y exteriores dan vida a ambientes fluidos y evocadores que dialogan armoniosamente con la naturaleza, con intervenciones decorativas de composiciones Palladiana y Path de 20mm.

В дизайне дома доминирует эффект натурального камня. Палитра теплых светлых цветов вместе с композициями Palladiana и Path 20 мм создают внутри и снаружи уютную и стильную обстановку, которая гармонично переключается с окружающей природой.



atlas concorde

Palladiana, with tiles arranged irregularly according to an ancient artisanal tradition, brings life to outdoor spaces.

La Palladiana, con le tessere disposte in maniera irregolare secondo un'antica tradizione artigianale, anima gli spazi outdoor.

La Palladiana, avec ses tesselles disposées de manière irrégulière selon une ancienne tradition artisanale, anime les espaces extérieurs.

Palladiana mit den nach alter Handwerkstradition unregelmäßig verlegten Mosaiksteinchen lässt Außenbereiche lebendig wirken.

Palladiana, con sus teselas dispuestas irregularmente según una antigua tradición artesanal, anima los espacios exteriores.

Palladiana, чи кусочки сложены в случайном порядке, оживляет наружные пространства в духе старинных традиций.



atlas concorde





atlas concorde



atlas concorde



atlas concorde



A VILLA FULL OF LIGHT WHETHER INSIDE OR OUT

atlas concorde



atlas concorde

The 60x120 format, available in Matt, Grip, and Textured 20 mm finishes, in addition to ensuring continuity between the indoors and outdoors, combines the earthy character of natural stone with the contemporary impact of the large format monolith.

Il formato 60x120, disponibile in finitura Matt, Grip e Textured 20mm, oltre a garantire continuità tra interno ed esterno, unisce la matericità della pietra naturale all'impatto di segno contemporaneo dato dal monolite in grande formato.

Le format 60x120, disponible en finition Matt, Grip et Textured 20 mm, outre à garantir la continuité entre l'intérieur et l'extérieur, allie le caractère de la pierre naturelle à l'impact du signe contemporain apporté par le monolithe grand format.

Das in den Ausführungen Matt, Grip und Textured 20 mm lieferbare Format 60x120 garantiert Kontinuität zwischen Innen- und Außenbereichen, und es vereint die Stofflichkeit des Natursteins mit dem hochmodernen Effekt des monolithischen Großformats.

El formato 60x120, disponible en acabado Matt, Grip y Textured de 20 mm, además de garantizar la continuidad entre el interior y el exterior, combina la materialidad de la piedra natural con el look contemporáneo de un monolito en gran formato.

Крупный формат 60x120, доступный в вариантах поверхности Matt, Grip и Textured 20 мм, помимо того что связывает между собой интерьер и улицу, придает рисунку природного камня эффектное современное звучание.



Items

ORO

OUTDOOR

60x120 cm | 23⁵/₈"x47¹/₄" Textured 20 mm
 60x90 cm | 23⁵/₈"x35³/₈" Textured 20 mm

Outdoor Decors

Path A+B Textured 20mm - 54x54 cm | 21¹/₄"x21¹/₄"
 Path C Textured 20mm - 55x109 cm | 21⁵/₈"x42⁷/₈"
 Composizione Palladiana Grip

INDOOR

30x60 cm | 11³/₄"x23⁵/₈" Roccia
 60x120 cm | 23⁵/₈"x47¹/₄" Matte/Matt

30x60 cm | 11³/₄"x23⁵/₈" Matte/Matt
 60x120 cm | 23⁵/₈"x47¹/₄" Matte/Matt
 Boost Pro Cream - 120x278 cm | 47¹/₄"x109¹/₂" Matte/Matt



NATURAL WELLNESS
AT HOME_

atlas concorde



atlas concorde



atlas concorde

TACTILE SURFACES FOR APPEALING INTERIORS

Porcelain floor and wall tiles in the Piombo tone have textures and colors that recall environments designed by nature.

Pavimenti e rivestimenti in gres porcellanato nel colore Piombo presentano texture e cromie che rimandano ad ambienti disegnati dalla natura.

Les revêtements sols et murs en grès cérame couleur Piombo présentent des textures et des tonalités qui évoquent les espaces dessinés par la nature.

Wand- und Bodenbeläge aus Feinsteinzeug in der Farbe Piombo bestechen mit Strukturen und Farben, die auf von der Natur geschaffene Räume verweisen.

Pavimentos y revestimientos de gres porcelánico en color Piombo presentan texturas y colores que recuerdan los ambientes diseñados por la naturaleza.

Фактуры и оттенки напольной и настенной плитки из керамогранита цвета Piombo такие же, как в природе.





atlasconcorde

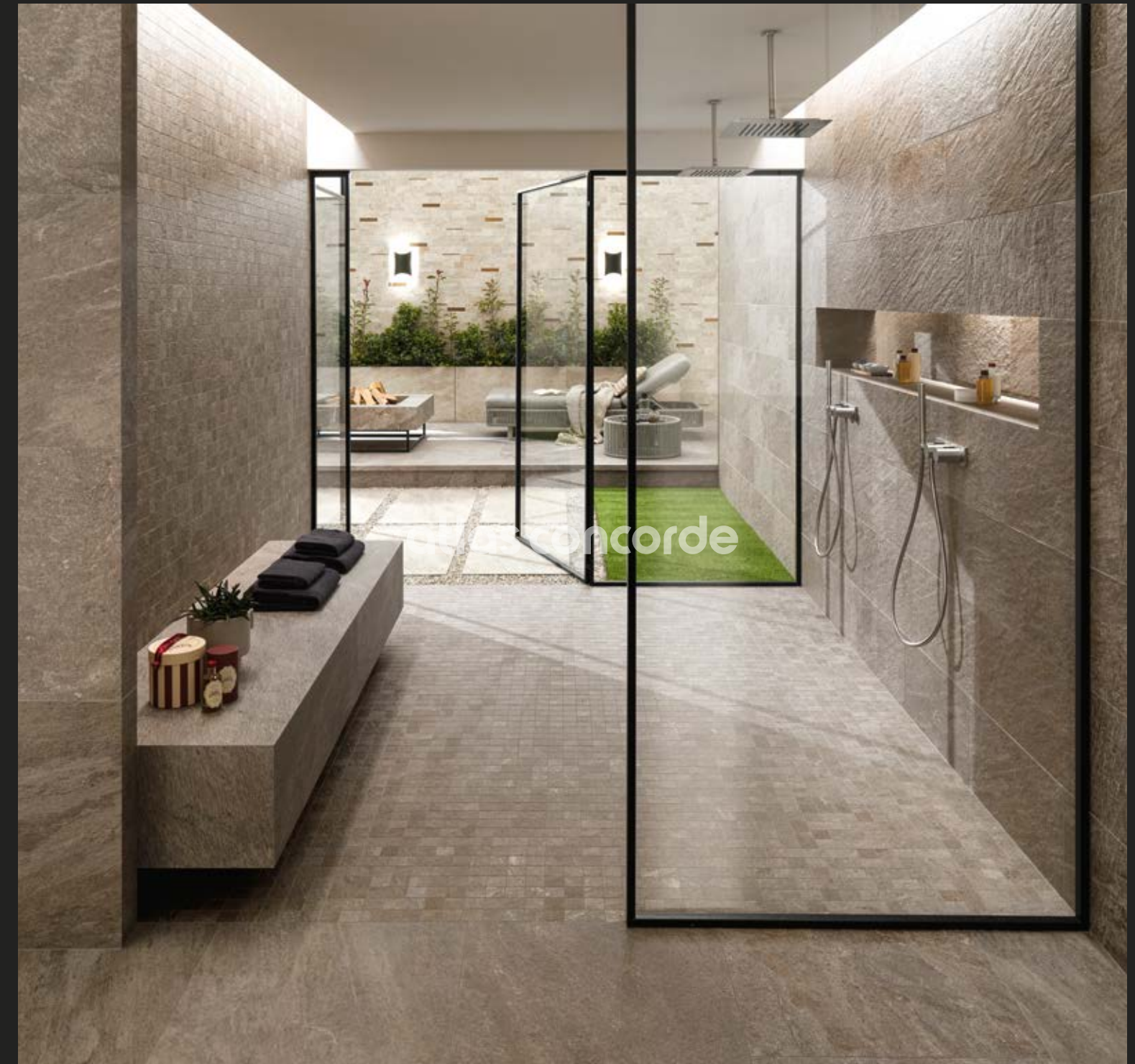

atlasconcorde

The Mosaico and Brick decorations offer customized solutions for interiors, bathrooms, showers, and exteriors.

I decori Mosaico e Brick offrono soluzioni su misura per interni, zona bagno e doccia, ed esterni.

Les décors Mosaico et Brick offrent des solutions sur mesure pour l'intérieur, les salles de bains et les espaces extérieurs.

Die Dekore Mosaico und Brick bieten maßgerechte Lösungen für Innenräume, Bad und Dusche sowie für Außenbereiche.

Las decoraciones Mosaic y Brick ofrecen soluciones a medida para interiores, zonas de baño y ducha, así como para exteriores.

Декоративные элементы Mosaico и Brick складываются в оригинальные решения для комнат, ванной, душевой кабины и наружных пространств.



atlas concorde



NATURAL WELLNESS AT HOME

atlas concorde

INDEX

OVERVIEW

SPACES

RANGE

TECH. SPECS



atlas concorde

In the Brick Corten, stone-look strips harmoniously alternate with Corten-look inserts polished on the crest. These recall the rusty nuances of Norde, creating an interesting interplay of color and light reflections.

Nel Brick Corten i listelli effetto pietra sono armonicamente alternati a inserti effetto Corten lappato in cresta. Questi richiamano le sfumature ruggine di Norde creando un interessante gioco cromatico e di riflessione della luce.

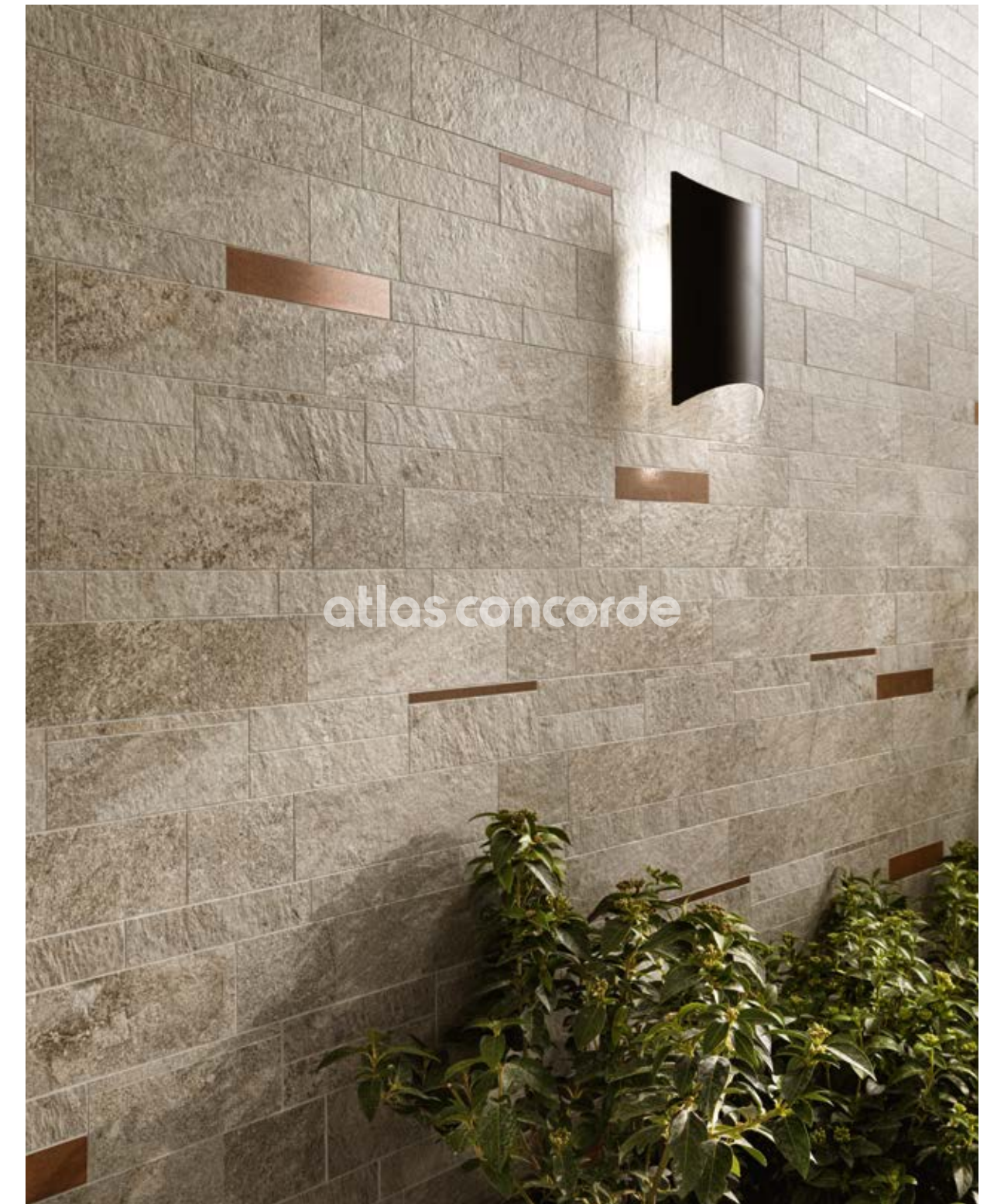

atlas concorde

Avec Brick Corten, les listels effet pierre s'alternent harmonieusement aux inserts effet Corten à crête polie. Ils rappellent les nuances rouille de Norde en créant un intéressant jeu de couleurs et de reflets de lumière.

Im Brick Corten wechseln Leisten in Natursteinoptik harmonisch mit anpolierten Corten-Einlegern ab. Sie erinnern an die rostigen Nuancen von Norde und erzeugen ein interessantes Spiel aus Farbe und Lichtreflexen.

En Brick Corten, los listeles efecto piedra se alternan armoniosamente con inserciones efecto Corten lapeados en la cresta. Estos recuerdan a los tonos de óxido de Norde, creando un interesante juego de colores y reflejos de luz.

В декоре Brick Corten рейки под камень гармонично чередуются с лапатированными в верхней части вставками под кортеговскую сталь. Последние повторяют ржавые оттенки плиток Norde, создавая интересную игру цвета и света.



Items

PIOMBO

INDOOR

30x60 cm | 11³/₄"x23⁵/₈" Roccia
60x120 cm | 23⁵/₈"x47¹/₄" Matte/Matt

Decors

Brick - 30x60 cm | 11³/₄"x23⁵/₈"
Mosaico Matt - 30x30 cm | 11³/₄"x11³/₄"

OUTDOOR

60x120 cm | 23⁵/₈"x47¹/₄" Textured 20 mm
30x60 cm | 11³/₄"x23⁵/₈" Roccia

PLATINO

OUTDOOR

60x120 cm | 23⁵/₈"x47¹/₄" Matte/Matt
60x120 cm | 23⁵/₈"x47¹/₄" Textured 20 mm

Decors

Brick Corten - 27,8x39 cm | 11"x15³/₈"

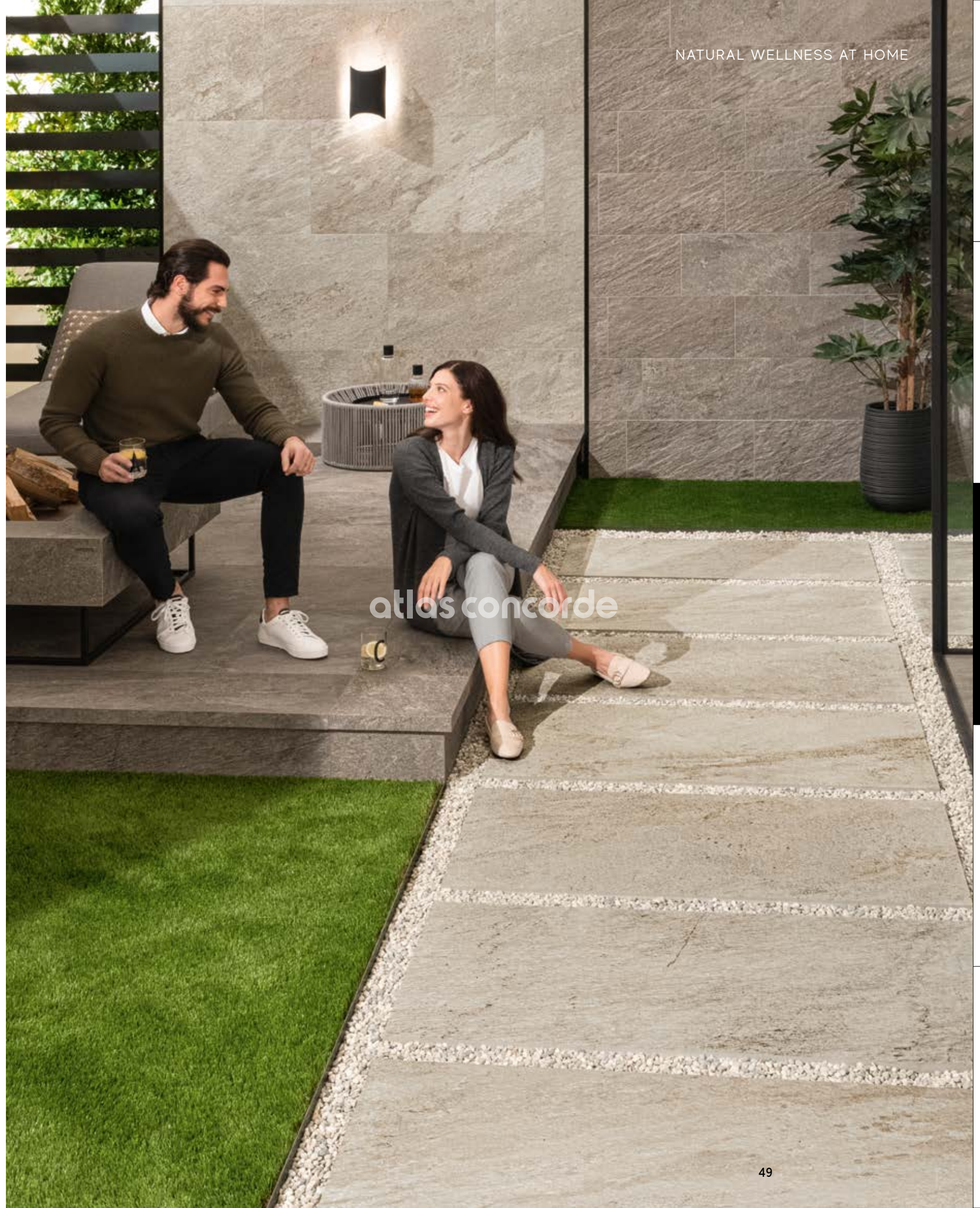



WINERY WITH A VIEW

atlasconcorde

SEAMLESS CONTINUITY BETWEEN INDOORS & OUT

The stone look evokes nature and unites indoor and outdoor spaces to create visual continuity and style. The distinctive characteristics of Norde are typical of quartzite with shading and rust-colored inclusions, while the sinuous horizontal veins give the material a delicate, warm coloring.

L'effetto pietra evoca la natura ed è l'elemento che unisce spazi interni ed esterni creando continuità visiva e di stile. I caratteri distintivi di Norde sono tipici della quarzite, con sfumature e inclusioni color ruggine, mentre le sinuose venature orizzontali conferiscono al materiale una colorazione delicata e calda.

L'effet pierre évoque la nature et est l'élément qui unit les espaces intérieurs et extérieurs en créant une continuité visuelle et stylistique. Les traits distinctifs de Norde sont ceux typiques du quartzite, avec des nuances et des inclusions couleur rouille, tandis que ses veinures horizontales et sinueses confèrent un ton chaud et délicat au matériau.

Steinoptik evoziert die Natur und bildet durch visuelle und stilistische Kontinuität das verbindende Element zwischen Innen- und Außenbereichen. Die besonderen Kennzeichen von Norde sind jene typischen des Quarzits mit seinen rostfarbenen Nuancen und Einschlüssen, während die weichen, waagerechten Äderungen dem Material eine delikate, warme Farbgebung verleihen.

El efecto piedra evoca la naturaleza y es el elemento que une los espacios interiores y exteriores, creando continuidad visual y de estilo. Los rasgos distintivos de Norde son típicos de la cuarcita, con matices e inclusiones color óxido, mientras que las sinuosas vetas horizontales dan un color suave y cálido al material.

Эффект камня вызывает в памяти природу и связывает внутренние и наружные пространства в одно стилистическое целое. Характерные особенности Norde переняты у кварцита: это оттенки и включения цвета ржавчины и извилистые прожилки, которые пронизывают поверхность мягким теплом.



atlas concorde



Unlike natural stone, porcelain tiles allow you to employ different sizes, finishes, and thicknesses for any type of use, indoors and out.

A differenza della pietra naturale, il gres porcellanato consente di realizzare diversi formati, finiture e spessori ideali per ogni tipo di destinazione d'uso, indoor e outdoor.

Contrairement à la pierre naturelle, le grès cérame permet de réaliser divers formats, finitions et épaisseurs, idéaux pour tous types d'utilisation, en intérieur et en extérieur.

Im Unterschied zum Naturstein bietet das Feinsteinzeug eine Vielfalt an Formaten, Oberflächen und Stärken, die für jeden Einsatzbereich ideal sind, in Innen- wie in Außenbereichen.

A diferencia de la piedra natural, el gres porcelánico permite crear diferentes formatos, acabados y espesores, ideales para todo tipo de uso, tanto en interiores como en exteriores.

В отличие от природного камня, керамогранит может иметь множество форматов, поверхностных отделок и толщин для любых применений в интерьере и на улице.





atlas concorde



WINERY WITH A VIEW

atlas concorde

Items

PLATINO

INDOOR

60x120 cm | 23⁵/₈"x47¹/₄" Matte/Matt
 Blaze Corten - 120x120 cm | 47¹/₄"x47¹/₄" Matte/Matt
 Blaze Corten - 120x278 cm | 47¹/₄"x109¹/₂" Matte/Matt

Decors

Brick Corten - 27,8x39 cm | 11"x15³/₈"

OUTDOOR

60x120 cm | 23⁵/₈"x47¹/₄" Grip

Decors

Brick - 30x60 cm | 11³/₄"x23⁵/₈"



SUITE WITH
A NATURAL FLAIR_

atlas concorde



atlas concorde



atlas concorde

THE PLEASURE OF LIVING CLOSE TO NATURE

The graphics inspired by the original quartzite bring out their rich colors and strong personality, with shading and rust-colored inclusions that, combined with the palette of the collection, give life to a product of great impact.

Le grafiche ispirate alla quarzite ne evidenziano la ricchezza cromatica e la personalità spiccata, con sfumature policromatiche e inclusioni color ruggine che, unito alle tonalità della collezione, danno vita ad un prodotto di grande impatto.

Les graphismes inspirés du quartzite en soulignent la richesse chromatique et le grand caractère, avec des nuances polychromes et des inclusions couleur rouille, qui alliées aux tonalités de la collection, donnent naissance à un produit de grand impact.

Die am Quarzit inspirierten Grafiken betonen den farblichen Reichtum und die ausgeprägte Persönlichkeit mit mehrfarbigen Nuancen und rostfarbenen Einschlüssen. Im Mix mit den Farben der Kollektion entsteht ein ausgesprochen effektvolles Produkt.

La gráfica inspirada en la cuarzita resalta su riqueza cromática y su fuerte personalidad, con tonos policromáticos e inclusiones de color óxido que, combinados con los tonos de la colección, crean un producto de gran impacto.

Рисунок кварцита отличается ярким характером и богатой расцветкой с вкраплением ржавых оттенков, которые придают плиткам коллекции эффектный вид.

The combination of stone-look wall tiles and wood-look flooring evokes relaxing, welcoming environments with a natural ambiance, underscored by the choice of shades, textures, and colors present in nature.

L'accostamento studiato tra il rivestimento effetto pietra ed il pavimento effetto legno evoca ambienti rilassanti e accoglienti con un'atmosfera di grande naturalità, evidenziata dalla scelta di tonalità, texture e cromie presenti in natura.

L'association étudiée entre le revêtement mural effet pierre et le sol effet bois évoque des espaces relaxants et accueillants où l'atmosphère est empreinte de naturalité, valorisée par le choix de tonalités, de textures et de couleurs présentes dans la nature.

Die gelungene Kombination des Wandbelags mit Steinoptik und Bodenbelag mit Holzoptik schafft einladende und entspannende Räume von ausgesprochen natürlicher Atmosphäre, die durch bewusst gewählte, von der Natur entlehnte Nuancen, Strukturen und Farben noch unterstrichen wird.

La estudiada combinación del revestimiento efecto piedra y el pavimento efecto madera evoca ambientes relajantes y acogedores con una atmósfera de gran naturalidad, resaltada por la elección de tonos, texturas y colores de la naturaleza.

Сочетание «каменных» стен и «деревянного» пола создает в интерьере спокойную натуральную атмосферу, а уют добавляют фактуры и цвета, которые встречаются в природе.

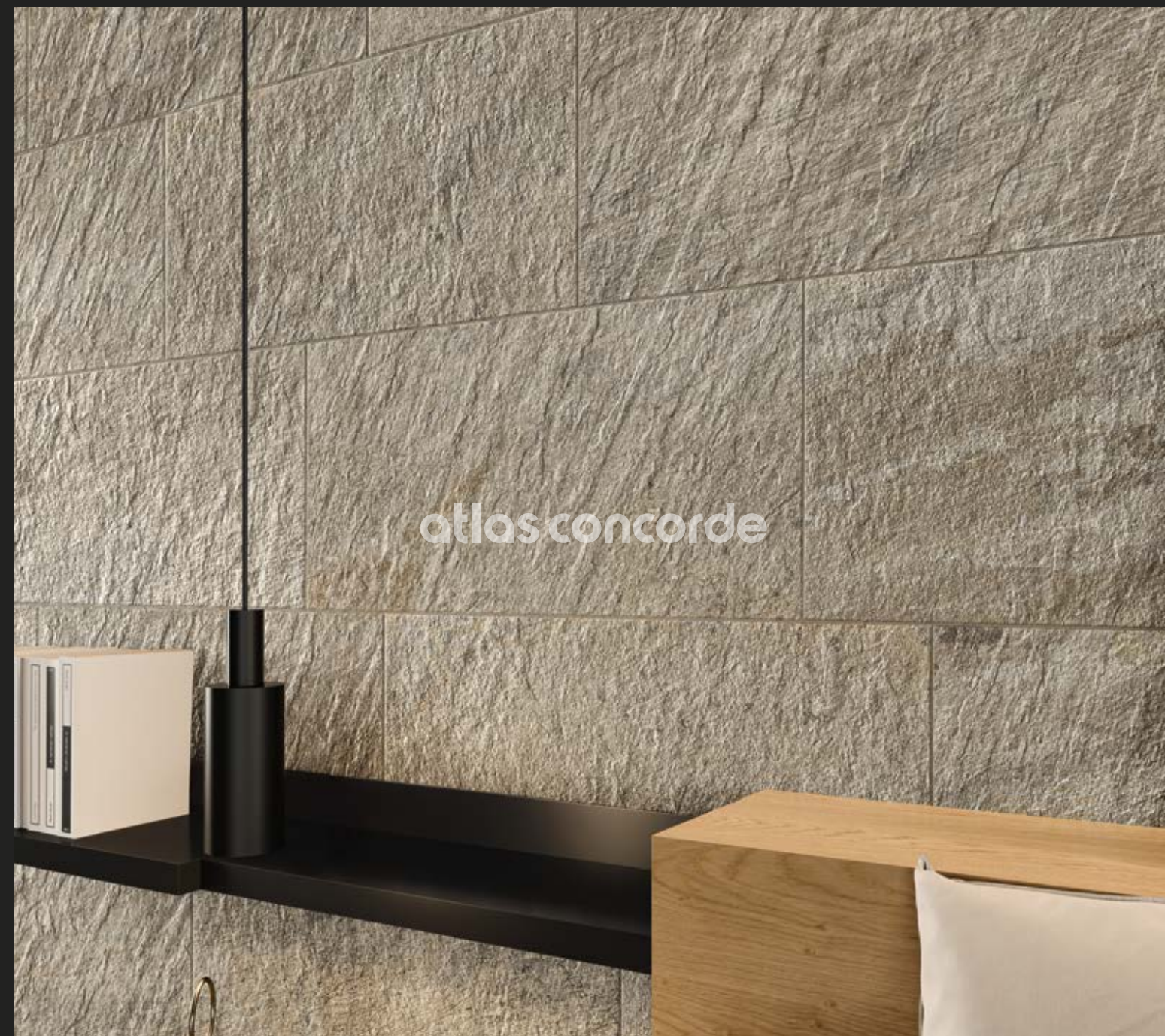



atlas concorde



atlas concorde

Items

PLATINO

30x60 cm | 11³/₄"x23⁵/₈" Roccia
60x120 cm | 23⁵/₈"x47¹/₄" Matte/Matt

Exence Almond - 20x120 cm | 7"x47¹/₄" Matte/Matt



ROCKY EFFECT IN A
MINIMALISTIC VILLA_

atlas concorde



atlas concorde



atlas concorde

A 3D SURFACE WITH A NATURAL LOOK

The reliefs and veins of the surfaces in the Magnesio shade are enhanced by the interplay of natural and non-natural light, creating indoor environments and outdoor spaces rich in ambiance.

I rilievi e le venature delle superfici nella tonalità Magnesio vengono valorizzati dai giochi di luce naturale e non, creando ambienti interni e spazi esterni ricchi di atmosfera.

Les reliefs et les veinures des surfaces couleur Magnesio sont valorisés par les jeux de lumière naturelle ou non, en créant des intérieurs et des espaces extérieurs riches en atmosphère.

Die Reliefs und Äderungen der Beläge in der Farbvariante Magnesio werden im Spiel mit natürlichem und künstlichem Licht hervorgehoben und erzeugen Innenräume und Außenbereiche voller Atmosphäre.

Los relieves y las vetas de las superficies en tonalidad Magnesio se ven realizados por el juego de la luz natural y artificial, creando ambientes interiores y espacios exteriores con una atmósfera única.

Рельефы и прожилки поверхности цвета Magnesio, подчеркнутые игрой естественного и искусственного света, создают в доме и на улице пленительную обстановку.



atlasconcorde



atlasconcorde

Composed of rectangular strips of different sizes, Brick is the most versatile mosaic and can be laid both horizontally and vertically, on the wall as well as on the floor, indoors and out.

Composto da listelli rettangolari di diverse dimensioni, Brick è il mosaico più versatile e si può posare sia in orizzontale che in verticale, a parete come a pavimento, indoor e outdoor.

Composé de listels rectangulaires de différentes tailles, Brick est la mosaïque la plus éclectique et peut être posée horizontalement ou verticalement, au mur ou au sol, en intérieur et en extérieur.

Das aus rechteckigen Leisten unterschiedlicher Größe bestehende Brick ist ein besonders vielseitiges Mosaik, das sowohl waagrecht als auch senkrecht verlegt werden kann, an der Wand wie am Boden, in Innen- und Außenbereichen.

Compuesto por listeles rectangulares de diferentes tamaños, Brick es el mosaico más versátil y puede instalarse tanto en horizontal como en vertical, en paredes y pavimentos, en interiores y exteriores.

Мозаику Brick, составленную из прямоугольных элементов разных размеров, отличает невероятная универсальность: укладывать ее можно горизонтально и вертикально, на пол и на стену, внутри помещений и в наружных пространствах.

INDEX

OVERVIEW

SPACES

RANGE

TECH. SPECS

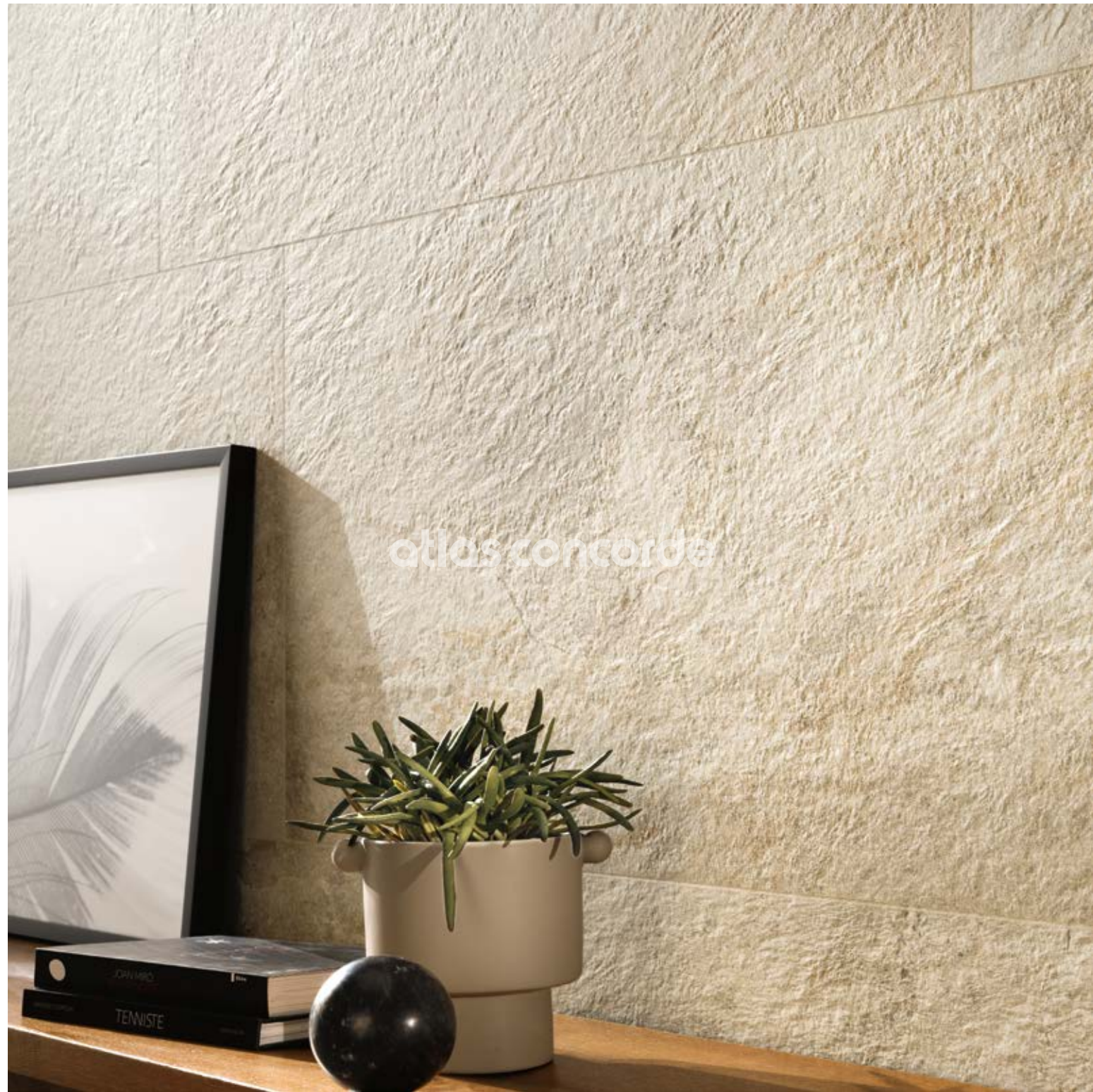

atlas concorde



ROCKY EFFECT IN A MINIMALISTIC VILLA

atlas concorde

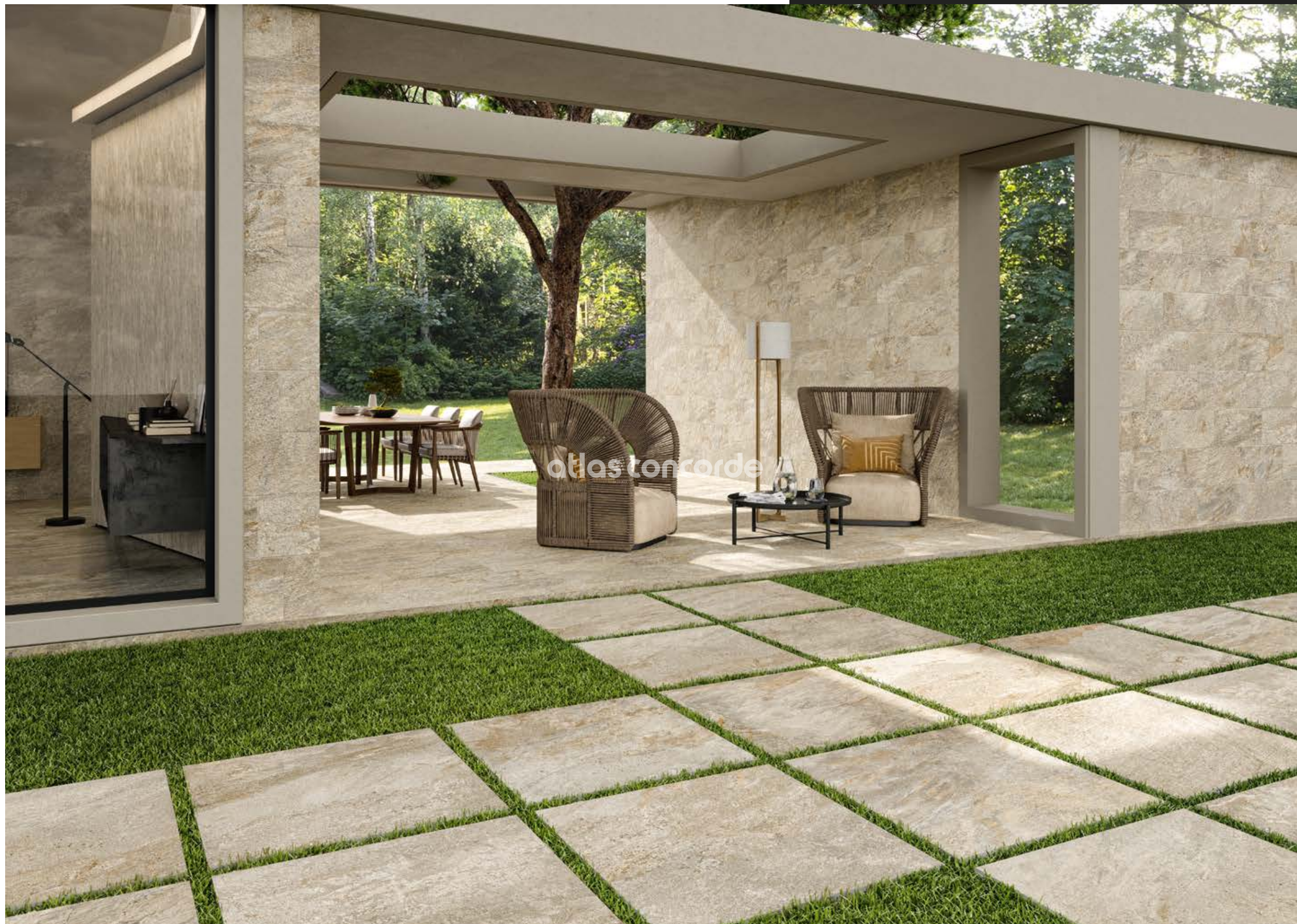

The collection includes tiles for both indoor and outdoor use, with 30x60 Roccia and 60x120 Grip formats and 20 mm slabs measuring 60x60, 60x90, 80x80, and 60x120 cm.

La collezione comprende proposte sia per l'indoor che per l'outdoor, con i formati 30x60 Roccia e 60x120 Grip e i formati 20mm 60x60, 60x90, 80x80 e 60x120 cm.

La collection comprend des propositions soit pour l'intérieur que pour l'extérieur, avec les formats 30x60 Roccia et 60x120 Grip, et les formats 20 mm 60x60, 60x90, 80x80 et 60x120 cm.

Die Kollektion umfasst Fliesen für innen und außen, mit den Formaten 30x60 Roccia und 60x120 Grip sowie den 20 mm starken Formaten 60x60, 60x90, 80x80 und 60x120 cm.

La colección incluye propuestas tanto para interiores como para exteriores, con los formatos 30x60 Roccia y 60x120 Grip, y los formatos 20mm 60x60, 60x90, 80x80 y 60x120 cm.

Коллекция включает как интерьерную, так и уличную плитку в форматах 30x60 Roccia и 60x120 Grip и в форматах 60x60, 60x90, 80x80, 60x120 см толщиной 20 мм.



The Roccia finish has a three-dimensional split texture. The surface, which can be used both on indoor and outdoor walls and for outdoor flooring, maintains the natural roughness of stone giving it a strong, gritty appearance while remaining compact and easy to clean.

La finitura Roccia presenta una struttura tridimensionale detta a spacco. La superficie, utilizzabile sia a parete, indoor o outdoor, che come pavimento esterno, mantiene le asperità naturali della pietra che le conferiscono un aspetto forte e grintoso, e al contempo compatto e di facile pulizia.

La finition Roccia présente une structure tridimensionnelle dite aussi de clivage. La surface, qui peut être posée soit au mur, en intérieur ou en extérieur, soit au sol en extérieur, maintient les aspérités naturelles de la pierre qui lui confèrent un aspect à la fois fort et incisif, compact et facile à nettoyer.

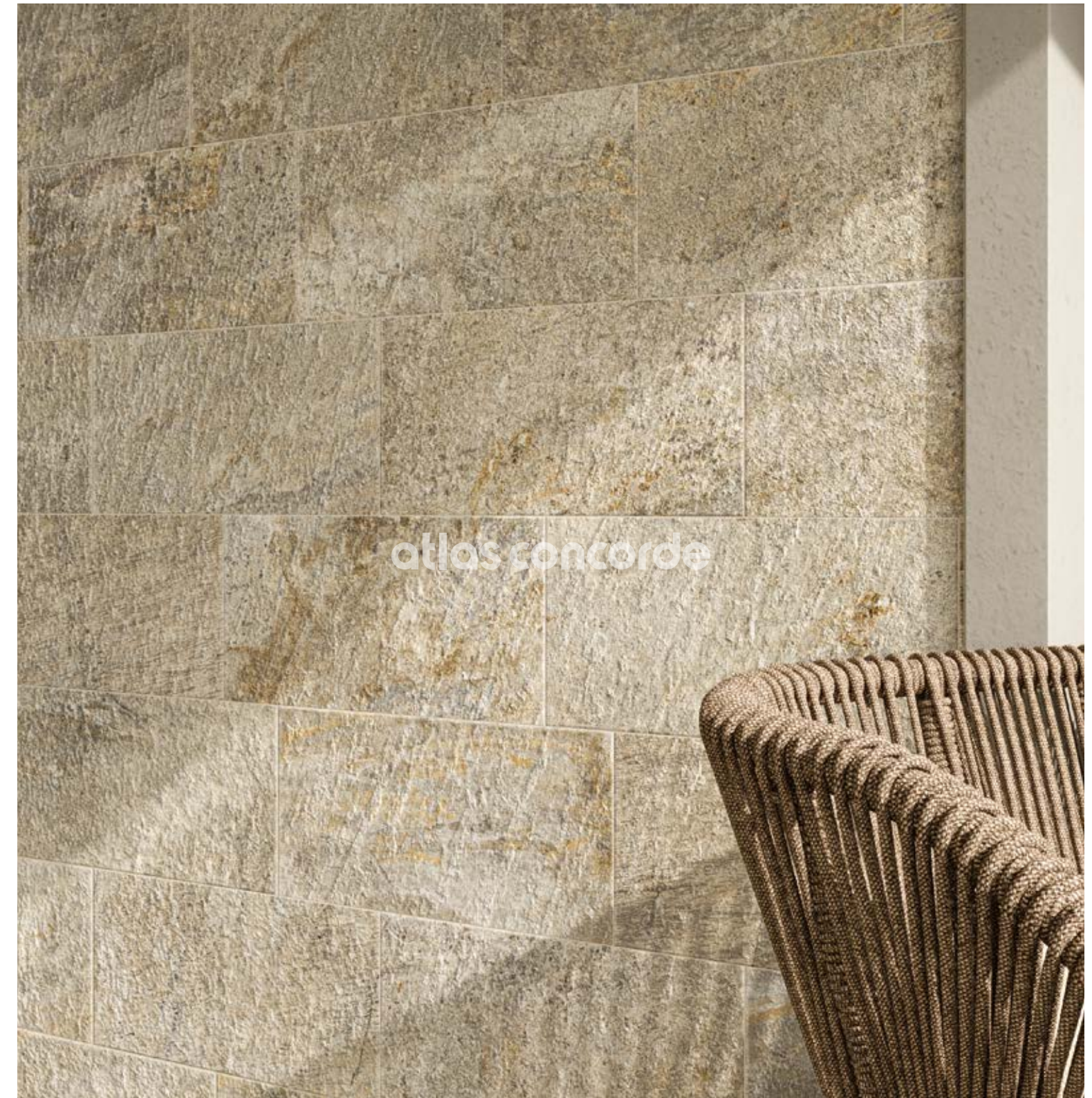

Die Oberflächenausführung Roccia besitzt eine dreidimensionale, als gespalten bezeichnete Struktur. Der Belag kann innen wie außen an Wand und Boden sowie als Boden im Außenbereich verwendet werden. Er weist die typische Unebenheit des Natursteins auf, die ihm eine starke, energische Ausstrahlung verleiht, ist aber gleichzeitig kompakt und einfach zu reinigen.

El acabado Roccia tiene una estructura tridimensional partida. La superficie puede utilizarse tanto en paredes, en interiores o exteriores, o como en pavimentos al aire libre, mantiene la aspereza natural de la piedra otorgándole un aspecto fuerte, resuelto, compacto y fácil de limpiar a la vez.

Поверхность Рокция имитирует трехмерную колотую фактуру и подходит для отделки стен внутри помещений и на улице и устройства уличных напольных покрытий. Характерна для нее такая же шероховатость и суровость, как у природного камня, но при этом она удивительно проста в уходе.



Items

MAGNESIO

INDOOR

60x120 cm | 23⁵/₈"x47¹/₄" Matte/Matt

Decors

Brick - 30x60 cm | 11³/₄"x23⁵/₈"

OUTDOOR

30x60 cm | 11³/₄"x23⁵/₈" Roccia
80x80 cm | 31¹/₂"x31¹/₂" Textured 20mm

Outdoor Decors

Path A+B - 54x54 cm | 21¹/₄"x21¹/₄" Textured 20mm
Path C - 55x109 cm | 21⁵/₈"x42⁷/₈" Textured 20mm

NORDE

Porcelain tiles

COLOURED BODY PORCELAIN TILES - RECTIFIED MONOCALIBER

GRES PORCELLANATO COLORATO IN MASSA - RETTIFICATO MONOCALIBRO

Grès cérame coloré dans la masse - Rectifié mono-calibre / Durchgefärbtes Feinsteinzeug - Geschliffen einkalibrig

Gres porcelánico coloreado en masa - Rectificado monocalibre / Керамический гранит окрашенный в массе - Ретифицированный в одном калибре



60x120cm - 23 ⁵ / ₈ "x47 ¹ / ₄ "	±9 mm	Matte	Matte	Matte	Matte
60x60cm - 23 ⁵ / ₈ "x23 ⁵ / ₈ "	±9 mm	Matte	Matte	Matte	Matte
30x60cm - 11 ³ / ₄ "x23 ⁵ / ₈ "	±9 mm	Matte	Matte	Matte	Matte



Outdoor and Wet Areas

30x60cm - 11 ³ / ₄ "x23 ⁵ / ₈ "	±9 mm	Roccia (Textured)	Roccia (Textured)	Roccia (Textured)	Roccia (Textured)
60x120cm - 23 ⁵ / ₈ "x47 ¹ / ₄ "	±9 mm	Grip	Grip	Grip	Grip
60x120cm - 23 ⁵ / ₈ "x47 ¹ / ₄ "	±20 mm	Textured	Textured	Textured	Textured
60x90cm - 23 ⁵ / ₈ "x35 ³ / ₈ "	±20 mm	Textured	Textured	Textured	Textured
80x80cm - 31 ¹ / ₂ "x31 ¹ / ₂ "	±20 mm	Textured	Textured	Textured	Textured
60x60cm - 23 ⁵ / ₈ "x23 ⁵ / ₈ "	±20 mm	Textured	Textured	Textured	Textured

Porcelain tiles ± 20 mm

For further details on the 20mm thick products, related trim pieces and installation systems - in particular for recommendations and precautions during installation- please refer to the [Outdoor Design section on the Atlas Concorde website](#) or to the [Outdoor Design catalogue](#). / Per dettagli sul prodotto e sui relativi pezzi speciali in 20mm di spessore, per i sistemi di posa e, in particolare, per raccomandazioni, accorgimenti e precauzioni in fase di posa e progettazione, si raccomanda di prendere visione del catalogo Outdoor Design e della sezione Outdoor Design del sito Atlas Concorde.

Destination of use

H Matte ± 9 mm
Grip ± 9 mm
Roccia ± 9 mm
Textured ± 20 mm

Anti-slip

R10 A+B Matte ± 9 mm
R11 A+B+C Grip ± 9 mm | Textured ± 20 mm
R12 A+B+C Roccia ± 9 mm

= Thickness

Color-shading

V3 Moderate Variation



MAGNESIO

ORO

PLATINO

PIOMBO

Porcelain tile decors

**Norde Magnesio
Brick**
30x60 cm - 11³/₄"x23⁵/₈"



**Norde Oro
Brick**
30x60 cm - 11³/₄"x23⁵/₈"



**Norde Platino
Brick**
30x60 cm - 11³/₄"x23⁵/₈"



**Norde Piombo
Brick**
30x60 cm - 11³/₄"x23⁵/₈"

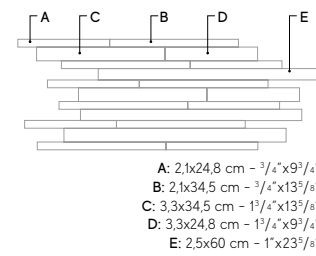

**Norde Magnesio
Brick Corten ***
27,8x39 cm - 11"x15³/₈"



**Norde Oro
Brick Corten ***
27,8x39 cm - 11"x15³/₈"



**Norde Platino
Brick Corten ***
27,8x39 cm - 11"x15³/₈"



**Norde Piombo
Brick Corten ***
27,8x39 cm - 11"x15³/₈"

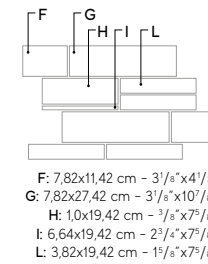

* **Blaze Corten Lappato tessera inserted randomly in four of the six sheets contained in each box** / Tessera Blaze Corten Lappato inserita in modo casuale in quattro dei sei fogli contenuti in ogni scatola / Tesselles Blaze Corten Lappato posées de manière aléatoire sur quatre des six feuilles contenues dans chaque boîte / Die Blaze Corten Lappato Steine werden nach dem Zufallsprinzip auf vier der sechs in jedem Karton enthaltenen Folien verklebt / Mosaico Blaze Corten Lappato insertado al azar en cuatro de las seis hojas que contiene cada caja / Чипса Blaze Corten Lappato включена случайным образом в четыре из шести матриц, содержащихся в каждой коробке

**Norde Magnesio
Mosaico Matt**
30x30 cm - 11³/₄"x11³/₄"



**Norde Oro
Mosaico Matt**
30x30 cm - 11³/₄"x11³/₄"

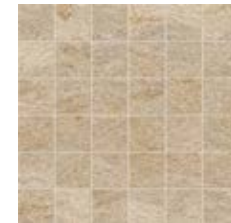

**Norde Platino
Mosaico Matt**
30x30 cm - 11³/₄"x11³/₄"

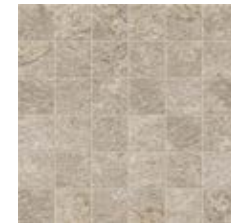

**Norde Piombo
Mosaico Matt**
30x30 cm - 11³/₄"x11³/₄"

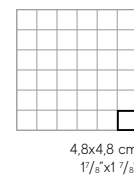
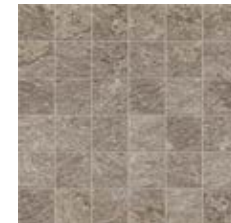

NORDE

Porcelain tile decors

Norde Magnesio
Composizione Palladiana Grip *



Norde Oro
Composizione Palladiana Grip *



Norde Platino
Composizione Palladiana Grip *



Norde Piombo
Composizione Palladiana Grip *



* Example of layout measuring about 1 m². Minimum order: 8 m². Variable tessera size and shape with tumbled edge. We recommend installation with a joint of no less than 10 mm / Esempio di posato corrispondente a circa 1 mq. Ordine minimo di 8 mq. Dimensione e forma delle tessere variabile con bordo burattato. Si consiglia posa con fuga non inferiore a 10 mm / Exemple de produit posé correspondant à 1 mètre carré environ. Commande minimum: 8 mètres carrés. Dimensions et forme des tesselles variables avec bord tamisé. Pose conseillée avec un joint non inférieur à 10mm / Verlegebeispiel für circa 1 qm. Mindestbestellmenge 8 qm. Abmessung und Form der Steine sind unterschiedlich, aber alle weisen getrommelte Kanten auf. Für die Verlegung wird eine Fugenbreite von nicht weniger als 10 mm empfohlen / Ejemplo de colocación correspondiente aproximadamente a 1 m. Pedido mínimo de 8 m. Tamaño y forma variable de los mosaicos con borde bruñido. Se recomienda colocación con junta de no menos de 10 mm / Пример укладки, соответствующий примерно 1 кв.м. Минимальный объем заказа – 8 кв.м. Размер и форма чипс варьируются, чипсы имеют выщербленные края. Рекомендуется укладка с межплиточным швом не менее 10 мм.

NORDE

Porcelain tile decors 20 mm

Norde Magnesio
Path A+B \approx 20 mm *
54x54 cm - 21¹/₄"x21¹/₄"

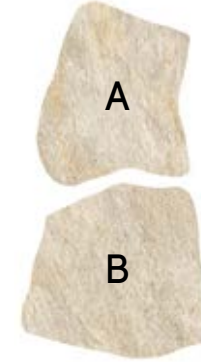

Norde Magnesio
Path C \approx 20 mm *
55x109 cm - 21⁵/₈"x42⁷/₈"



Norde Oro
Path A+B \approx 20 mm *
54x54 cm - 21¹/₄"x21¹/₄"

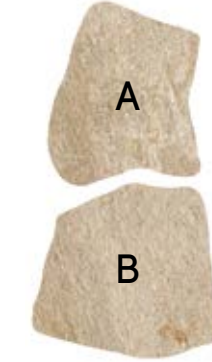

Norde Oro
Path C \approx 20 mm *
55x109 cm - 21⁵/₈"x42⁷/₈"



Norde Platino
Path A+B \approx 20 mm *
54x54 cm - 21¹/₄"x21¹/₄"

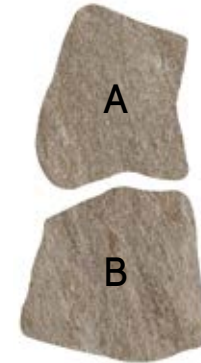

Norde Platino
Path C \approx 20 mm *
55x109 cm - 21⁵/₈"x42⁷/₈"



Norde Piombo
Path A+B \approx 20 mm *
54x54 cm - 21¹/₄"x21¹/₄"

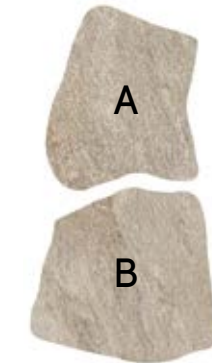

Norde Piombo
Path C \approx 20 mm *
55x109 cm - 21⁵/₈"x42⁷/₈"



* We recommend "dry" installation on gravel and/or grass / Si consiglia posa "a secco" su ghiaia e/o erba / Pose « à sec » sur gravillons et/ou herbe conseillée / Es wird eine Trockenverlegung auf Kies bzw. Rasen empfohlen / Se recomienda colocación «en seco» sobre grava o hierba / Рекомендуется «сухая» укладка на гравий и/или траву.



NORDE

Porcelain tile decors 20 mm

NORDE PATH TILE PATTERNS / SCHEMI DI POSA NORDE PATH
SCHÉMAS DE POSE NORDE PATH / NORDE PATH-VERLEGEPLÄNE
ESQUEMA DE COLOCACIÓN NORDE PATH / СХЕМЫ УКЛАДКИ NORDE PATH

Pattern Path A+B



Pattern Path C



Pattern Path A+B+C



NORDE

Trim tiles

INDOOR TRIM TILES

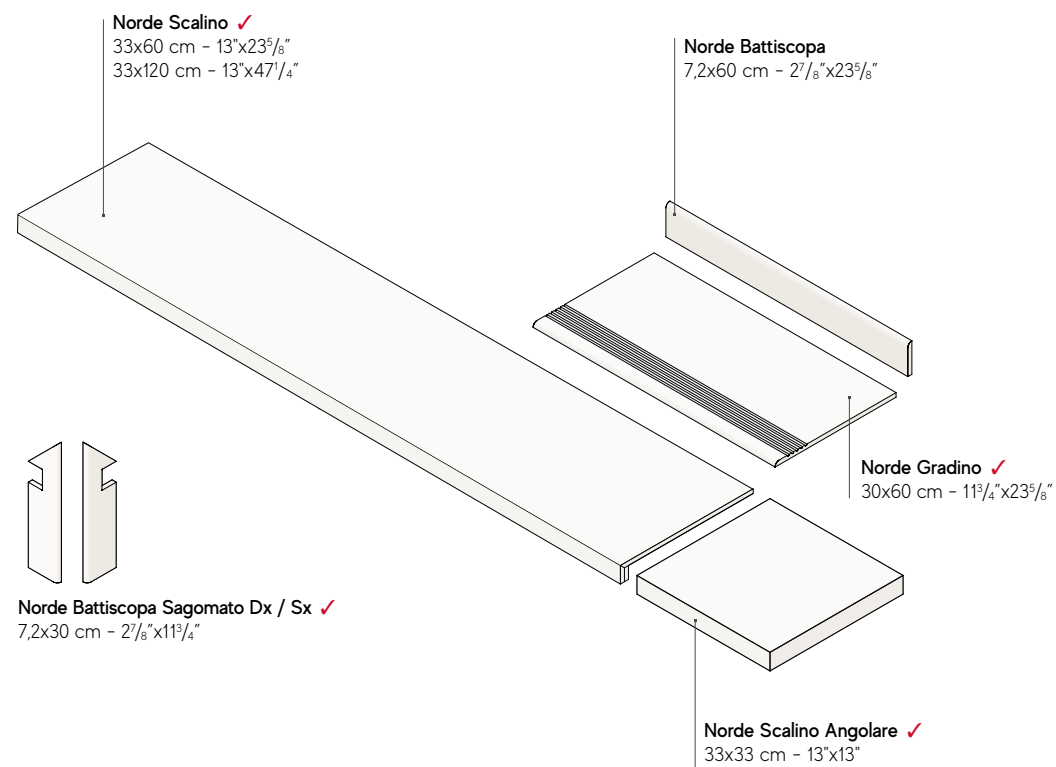

✓ These parts are supplied to order / I pezzi sono disponibili su ordinazione

Outdoor trim tiles ± 20 mm

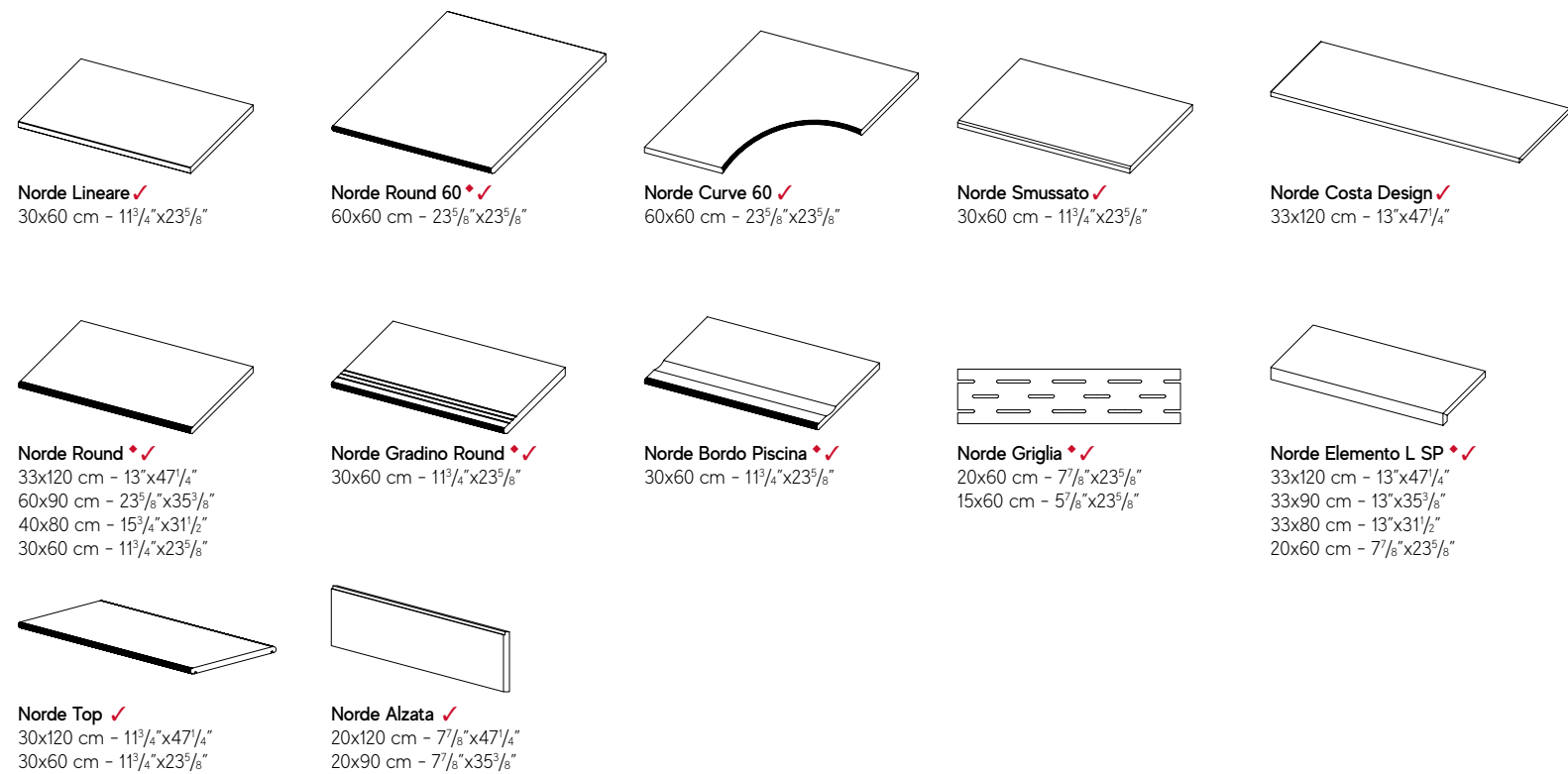

♦ Right/left angular elements are available / Sono disponibili gli elementi angolari dx/sx
✓ These parts are supplied to order / I pezzi sono disponibili su ordinazione

OUTDOOR TRIM TILES

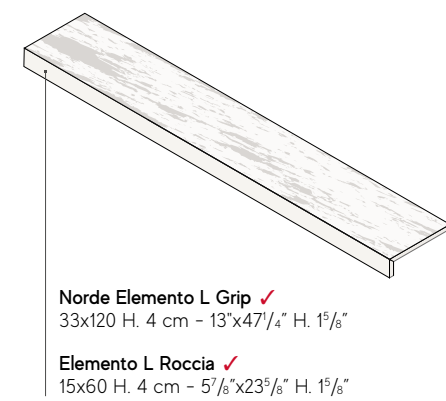

THANKS TO



NOTES / NOTE

For information and details relating to codes, packaging and weight it is recommended to refer to the latest pricelist. | Per le informazioni e i dati relativi a codici, imballaggi e pesi occorre sempre consultare l'ultimo listino aggiornato e in vigore. | Pour toutes informations et renseignements concernant les codes, les emballages et les poids, il y a toujours lieu de consulter le dernier tarif en vigueur et mis à jour. | Für Informationen und Daten die den Code, die Verpackung und das Gewicht betreffen bitte die aktuellste Preisliste zugrunde legen. | Para acceder a la información y a los datos relativos a códigos, embalajes y pesos hay que consultar siempre la última lista de precios actualizada y vigente. | Для информации о кодах, упаковках и весе обращайтесь к последнему действующему прайс-листу.

Colors and optical features of the materials illustrated in this catalogue are to be regarded as mere indications. | I colori e le caratteristiche estetiche dei materiali illustrati nel presente catalogo sono da ritenersi puramente indicativi. | Les coloris et les caractéristiques esthétiques des références illustrées dans le catalogue sont donnés à titre purement indicatif. | Die Farben und die ästhetischen Eigenschaften der in diesem Katalog abgebildeten Produkte sind als reine Richtwerte zu betrachten. | Los colores y las características estéticas de los materiales ilustrados en el presente catálogo deben ser considerados como puramente indicativos. | Цвета и эстетические характеристики описанных в настоящем каталоге материалов являются только ориентировочными.

Atlas Concorde reserves the right to modify any product without notice and will not be liable for any direct or indirect damage resulting from such modifications. | Atlas Concorde si riserva di modificare i prodotti senza preavviso, declinando ogni responsabilità su eventuali danni diretti o indiretti derivanti da eventuali modifiche. | Atlas Concorde se réserve le droit de modifier ses produits sans préavis et décline toute responsabilité concernant les éventuels dommages directs ou indirects qui pourraient dériver de ces modifications. | Atlas Concorde behält sich das Recht vor jederzeit und ohne vorherige Ankündigung, die Produkte zu verändern, und lehnt jede Haftung bei direkten oder indirekten Schäden ab, die von diesen Veränderungen herrühren. | Atlas Concorde se reserva el derecho de modificar los productos sin previo aviso, rechaza cualquier responsabilidad sobre eventuales daños directos o indirectos derivados de eventuales modificaciones. | Atlas Concorde оставляет за собой право изменять характеристики изделий без предварительного уведомления, отклоняя при этом любую ответственность за прямые или косвенные убытки, возникшие в результате изменений.

CERAMIC AND PORCELAIN TILES: A SAFE CHOICE

Resistance and duration

RESISTENZA E DURATA

Easy to maintain

Facile da mantenere



Porcelain tiles do not require any special maintenance.

Il gres porcellanato non richiede manutenzioni particolari.

UV Resistant

Resistente ai raggi UV



Porcelain tiles maintain their colors even when exposed to continuous, direct sunlight or in contact with atmospheric agents or smog.

Il gres porcellanato rimane inalterato nei suoi colori anche se esposto alla luce diretta e continua del sole o a contatto con agenti atmosferici o smog.

Scratch resistant

Resistente al graffio

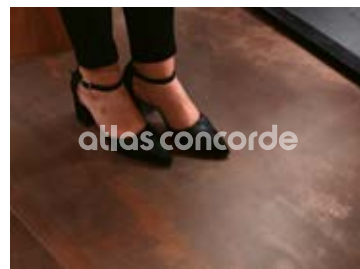

Porcelain tiles do not splinter, break or get damaged.

Il gres porcellanato non si scheggia, non si rompe e non si danneggia.

Easy to clean

Facile da pulire



Porcelain tiles are easy to clean.

Il gres porcellanato si pulisce facilmente.

Waterproof

Resistente all'acqua

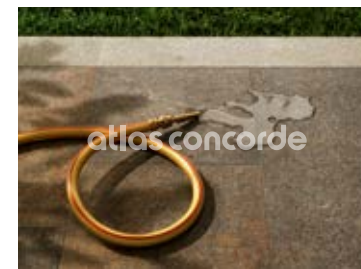

Porcelain tiles are completely non-porous and therefore are not damaged by water or humidity.

Il gres porcellanato è completamente non poroso e non teme l'acqua e l'umidità.

Stain resistant

Resistente alle macchie



Porcelain tiles are waterproof, no liquid can damage the surface.

Il gres porcellanato è impermeabile e nessun tipo di liquido può danneggiarne la superficie.

Resistant to chemicals

Resistente agli agenti chimici



Porcelain tiles do not stain and resist the most aggressive chemical agents.

Il gres porcellanato non si macchia e resiste agli agenti chimici più aggressivi.

Resistant to acids

Resistente agli acidi



Porcelain tiles are resistant to acids found in food and cleaning products.

Il gres porcellanato resiste agli acidi di uso alimentare e domestico.

Resistant to thermal shock

Resistente agli shock termici



A porcelain tile floor will not change as a result of sharp temperature fluctuations.

Un pavimento in gres porcellanato non si altera a causa di sbalzi termici.

Frost resistant

Resistente al ghiaccio



Porcelain tiles are frost resistant and therefore are not damaged by low temperatures.

Il gres porcellanato è ingelivo e resiste alle temperature più basse.

Health

SALUTE

Zero VOCS

Zero VOC



Porcelain tiles are intrinsically inorganic and do not emit volatile organic compounds (VOC).

Le piastrelle in gres porcellanato sono intrinsecamente inorganiche e non emettono composti organici volatili.

Zero PVC

Zero PVC



Porcelain tiles contain no PVC, plastics or petroleum derivatives.

Il gres porcellanato è privo di PVC, plastiche o derivati del petrolio.

Zero formaldehyde

Zero formaldeide



Porcelain tiles do not contain formaldehyde.

Il gres porcellanato non contiene formaldeide.

Zero allergens

Zero allergeni



Porcelain tiles are inhospitable for mites, bacteria, fungi, molds, and other irritants.

Il gres porcellanato è inospitale per acari, batteri, funghi, muffe e altre sostanze irritanti.

Prevent bacterial growth

Previene la crescita batterica



Porcelain tiles are completely hygienic and inhospitable for bacteria, mites, molds, and fungi.

Il gres porcellanato è assolutamente igienico e inospitale per i batteri, acari, muffe e funghi.

SAFETY

SICUREZZA

Non-slip

Antiscivolo



Porcelain tile surfaces can be made with an abrasive surface grit that can increase traction and reduce the risk of slipping.

Le superfici in gres porcellanato possono essere realizzate con una graniglia abrasiva superficiale in grado di aumentare la trazione e ridurre i rischi di scivolamento.

Fire resistant

Resistente al fuoco



Porcelain tiles are not flammable, reduce the spread of flames, do not burn, and do not emit toxic fumes.

Le piastrelle in gres porcellanato non sono infiammabili, riducono la propagazione della fiamma, non bruciano e non emettono fumi tossici.

Heat resistant

Resistente al calore



Porcelain tiles do not change shape at high temperatures.

Il gres porcellanato non si altera alle alte temperature.

Environment

AMBIENTE

Energy efficiency

Efficienza energetica



The high thermal inertia of porcelain tiles moderates the changes in temperature of the rooms, favoring energy savings.

L'elevata inerzia termica del gres porcellanato modera gli sbalzi di temperatura degli ambienti, favorendo il risparmio energetico.

Ecological

Ecologico



Porcelain tiles have a low environmental impact at all stages of their production, from the raw materials to disposal and recycling.

Il gres porcellanato ha un basso impatto ambientale in tutte le fasi del suo processo industriale, dalle materie prime fino allo smaltimento e al riciclo.

Recycling and re-use

Riciclo e riutilizzo



Porcelain tiles are made with recycled materials, last a long time, and can be re-used because they retain their original appearance.

Il gres porcellanato è realizzato con materiali di riciclo, dura a lungo e mantenendo l'aspetto originario può essere riciclato.

Ideal for floor heating systems

Ideale per sistemi di riscaldamento a pavimento



Porcelain tiles can be effectively combined with floor heating systems.

Il gres porcellanato può essere abbinato in modo efficace a sistemi di riscaldamento a pavimento.

Coloured body porcelain tiles - Rectified monocaliber



Compliant with standards EN 14411 annex G group B
Compliant with standards ISO 13006 annex G group B
Conforme alla norma EN 14411 Appendice G gruppo B
Conforme alla norma ISO 13006 Appendice G gruppo B

Gres porcellanato colorato in massa - Rettificato monocalibro

60x120 cm - 23³/₈"x47¹/₂"
60x60 cm - 23³/₈"x23³/₈"
30x60 cm - 11⁷/₈"x23³/₈"
± 9 mm
± 9 mm
± 9 mm
60x120 cm - 23³/₈"x47¹/₂"
60x90 cm - 23³/₈"x35³/₈"
60x60 cm - 23³/₈"x23³/₈"
80x80 cm - 31¹/₂"x31¹/₂"
± 20 mm
± 20 mm
± 20 mm
± 20 mm

Technical features Caratteristiche tecniche	Test Method Metodo di prova	Requirements for nominal size N / Requisiti per dimensione nominale N		
		7 cm ≤ N < 15 cm (mm)	N ≥ 15 cm (%) (mm)	
Length and width Lunghezza e larghezza	ISO 10545-2	± 0,9 (*) Non-rect. ± 0,4 (*) Rect.	± 0,6 (*) Non-rect. ± 0,3 (*) Rect.	± 2,0 (*) Non-rect. ± 1,0 (*) Rect.
Thickness Spessore		± 0,5 (**)		
Straightness of sides Rettilineità degli spigoli		± 0,8 (***) Non-rect. ± 0,4 (***) Rect.	± 0,5 (***) Non-rect. ± 0,3 (***) Rect.	± 1,5 (***) Non-rect. ± 0,8 (***) Rect.
Rectangularity Ortogonalità		± 0,8 (****) Non-rect. ± 0,4 (****) Rect.	± 0,5 (****) Non-rect. ± 0,3 (****) Rect.	± 2,0 (****) Non-rect. ± 1,5 (****) Rect.
Surface flatness Planarità	ISO 10545-2	c.c. ± 0,8 Non-rect. c.c. ± 0,6 Rect.	c.c. ± 0,5 Non-rect. c.c. ± 0,4 Rect.	c.c. ± 2,0 Non-rect. c.c. ± 1,8 Rect.
Water absorption (in% by mass) Massa d'acqua assorbita (come % della massa)	ISO 10545-3 ASTM C 373-18	E _v ≤ 0,5% Individual Maximum 0,6% E _v ≤ 0,5% Valore massimo singolo 0,6%		
Breaking strength Sforzo di rottura	ISO 10545-4	S ≥ 700N (for thickness < 7,5 mm - per spessore < 7,5 mm) S ≥ 1300N (for thickness ≥ 7,5 mm - per spessore ≥ 7,5 mm)		
Modulus of rupture Resistenza alla flessione		R ≥ 35 N/mm ²		
Bending strength and breaking load Resistenza a flessione e al carico di rottura (4)(5)	EN 1339 Annex F	-		
Impact resistance, as coefficient of restitution Resistenza all'impatto, espresso come coefficiente di restituzione	ISO 10545-5	Declared value Valore dichiarato		
Mohs hardness Durezza Mohs	EN 101	-		
Resistance to deep abrasion of unglazed tiles (removed volume) Resistenza all'abrasione profonda delle piastrelle non smaltate (volume materiale asportato)	ISO 10545-6	≤ 175 mm ³		
Coefficient of thermal linear expansion Coefficiente di dilatazione termica lineare	ISO 10545-8	Declared value Valore dichiarato		
Thermal shock resistance Resistenza agli sbalzi termici	ISO 10545-9	Pass according to EN ISO 10545-1 Test superato in accordo con ISO 10545-1		
Moisture expansion (in mm/m) Dilatazione all'umidità (in mm/m)	ISO 10545-10	Declared value Valore dichiarato		
Frost resistance Resistenza al gelo	ISO 10545-12	Pass according to EN ISO 10545-1 Test superato in accordo con ISO 10545-1		
Bond strength/adhesion for improved cementitious adhesives Adesione a trazione con adesivi cementizi migliorati	EN 1348	Declared value Valore dichiarato		
Reaction to fire Reazione al fuoco	-	Class A1 or A1 _s Classe A1 oppure A1 _s		
Resistance to household chemicals and swimming pool salts Resistenza ai prodotti chimici di uso domestico e agli additivi per piscina	ISO 10545-13	Minimum Class B Classe minima B		
Resistance to low concentrations of acids and alkalis Resistenza a basse concentrazioni di acidi e alcali		Declared Class Classe dichiarata		
Resistance to high concentrations of acids and alkalis Resistenza ad alte concentrazioni di acidi e alcali		Declared Class Classe dichiarata		
Resistance to staining for unglazed tiles Resistenza alle macchie per piastrelle non smaltate	ISO 10545-14	Declared Class Classe dichiarata		
Shod Ramp Test Metodo della rampa "calzato"	DIN 51130	Declared value Valore dichiarato		
Barefoot Ramp Test Metodo della rampa a piedi nudi	DIN 51097	Declared value Valore dichiarato		
Pendulum Friction Test Metodo del Pendolo	BS 7976	PTV ≥ 36 classifies the surface as "low slip risk"		
	AS 4586	Declared Classification of the new pedestrian surface materials according to the Pendulum Test		
	UNE-ENV 12633 UNE 41901:2017 EX	Declared value Valore dichiarato		
Coefficient of friction (COF) Coefficiente di attrito	B.C.R.A. Rep. CEC/81	D. M. 236/89 del 14/06/89 μ > 0,40 per elemento scivolante cuoio su pavimentazione asciutta μ > 0,40 per elemento scivolante gomma dura su pavimentazione bagnata		
Dynamic coefficient of friction (DCOF) Coefficiente di attrito dinamico	ANSI A137.1	ANSI A.137.1-2017 Requires a minimum value of 0.42 for level interior space expected to be walked upon when wet. (3)		

(*) The permissible deviation, in % or mm, of the average size for each tile (2 or 4 sides) from work size (WS). Deviazione ammissibile, in % oppure mm, della dimensione media di ogni piastrella (2 oppure 4 lati) dalla dimensione di fabbricazione (WS).
(**) The permissible deviation, in % or mm, of the average thickness for each tile from the work size thickness (WS). Deviazione ammissibile, in % oppure mm, dello spessore medio di ogni piastrella dallo spessore riportato nella dimensione di fabbricazione (WS).
(***) The maximum permissible deviation from straightness, in % or mm, related to the corresponding work sizes (WS). Deviazione massima ammissibile di rettilineità, in % oppure mm, in rapporto alle dimensioni di fabbricazione (WS) corrispondenti.
(****) The maximum permissible deviation from rectangularity, in % or mm, related to the corresponding work sizes (WS). Deviazione massima ammissibile di ortogonalità, in % oppure mm, in rapporto alle dimensioni di fabbricazione (WS) corrispondenti.

c.c. The maximum permissible deviation from centre curvature, in % or mm, related to diagonal calculated from the work sizes (WS). Deviazione massima ammissibile della curvatura del centro, in % oppure mm, in rapporto alla diagonale calcolata secondo le dimensioni di fabbricazione (WS).
e.c. The maximum permissible deviation from edge curvature, in % or mm, related to the corresponding work sizes (WS). Deviazione massima ammissibile della curvatura dello spigolo, in % oppure mm, in rapporto alle dimensioni di fabbricazione (WS) corrispondenti.
w. The maximum permissible deviation from warpage, in % or mm, related to diagonal calculated from the work sizes (WS). Deviazione massima ammissibile dello svergolamento, in % oppure mm, in rapporto alla diagonale calcolata secondo le dimensioni di fabbricazione (WS).
(1). Determination of slip resistance of pedestrian surfaces; it does not cover sports surfaces and road surfaces for vehicles (skid resistance). Determinazione della resistenza allo scivolamento delle superfici pedonabili; non si applica alle pavimentazioni sportive e alle pavimentazioni stradali veicolari.
(2). Anti-slip performance is guaranteed at the time of delivery of the product. Le prestazioni anti-slip vengono garantite al momento della consegna del prodotto.
(3). However, tiles with a DCOF of 0.42 or greater are not necessarily suitable for all projects. The specifier shall determine tiles appropriate for specific project conditions, considering by way of example, but not in limitation, type of use, traffic, expected contaminants, expected maintenance, expected wear, and manufacturers' guidelines and recommendations.
(4). For further details, please refer to outdoor design general catalogue. Per maggiori informazioni riferirsi al catalogo generale Outdoor Design.
(5). Only for products with 20 mm thickness. Solo per prodotti a 20mm di spessore.

(*) If not rectified: "Suitable for". Se non rettificato: "Conforme".

INDEX

OVERVIEW

SPACES

RANGE

TECH. SPECS

LE GRÈS CÉRAME : LE CHOIX SÛR / DAS FEINSTEINZEUG: EINE SICHERE WAHL / GRES PORCELÁNICO: LA ELECCIÓN SEGURA / КЕРАМИКА: НАДЕЖНЫЙ ВЫБОР

Résistance et longévité / Widerstandsfähigkeit und Lebensdauer / Resistencia y durabilidad / Стойкость и долговечность

Résistance et longévité / Widerstandsfähigkeit und Lebensdauer / Resistencia y durabilidad / Стойкость и долговечность

Entretien facile / Leicht zu warten / Fácil de mantener / Простота ухода

Entretien facile / Leicht zu warten / Fácil de mantener / Простота ухода

Le grès cérame n'exige aucun entretien particulier. / Feinsteinzeug erfordert keine besonderen Wartungsarbeiten. / El gres porcelánico no requiere particulares operaciones de mantenimiento. / Керамогранит не нуждается в особом уходе.

Résistant aux rayons UV / UV-Strahlenfest / Resistente a los rayos UV / Стойкость к УФ-излучению

Résistant aux rayons UV / UV-Strahlenfest / Resistente a los rayos UV / Стойкость к УФ-излучению

Les coloris du grès cérame restent inaltérés même s'il est exposé à la lumière directe et continue du soleil ou au contact du smog et des agents atmosphériques. / Die Farben des Feinsteinzeugs bleiben unverändert erhalten, auch wenn es direktem und ständigem Sonnenlicht, der Witterung oder Smog ausgesetzt ist. / El gres porcelánico no se altera con el paso del tiempo, tampoco cambia su color cuando está expuesto a la luz directa y continua del sol o cuando entra en contacto con agentes climatológicos o contaminación. / Керамогранит не выцветает даже при постоянном воздействии солнечного света, атмосферных факторов, смога.

Résistant aux rayures / Kratzfestigkeit / Resistente a las rayas / Стойкость к царапинам

Résistant aux rayures / Kratzfestigkeit / Resistente a las rayas / Стойкость к царапинам

Le grès cérame ne subit ni ébréchures, ni cassures, ni dommages. / Feinsteinzeug splittert nicht, es zerbricht nicht und erleidet keine Beschädigungen. / El gres porcelánico no se desportilla, no se rompe y no se estropea. / Керамогранит не раскалывается, не ломается, не повреждается.

Facile à nettoyer / Leicht zu reinigen / De fácil limpieza / Легкость чистки

Facile à nettoyer / Leicht zu reinigen / De fácil limpieza / Легкость чистки

Le grès cérame se nettoie facilement. / Feinsteinzeug kann leicht gereinigt werden. / El gres porcelánico se limpia fácilmente. / Керамогранит легко очищается.

Résistant aux taches / Fleckenfestigkeit / Resistente a las manchas / Стойкость к пятнам

Résistant aux taches / Fleckenfestigkeit / Resistente a las manchas / Стойкость к пятнам

Le grès cérame est imperméable et aucun type de liquide ne peut endommager sa surface. / Feinsteinzeug ist wasserundurchlässig und Flüssigkeiten jeglicher Art können seine Oberfläche nicht beschädigen. / El gres porcelánico es impermeable y ningún tipo de liquido puede estropear la superficie. / Керамогранит непроницаем, и никакая жидкость не может повредить его поверхность.

Résistant aux agents chimiques / Beständigkeit gegen Chemikalien / Resistente a los agentes químicos / Стойкость к химическим веществам

Le grès cérame ne se tache pas et résiste aux agents chimiques les plus agressifs. / Feinsteinzeug ist fleckenfest und beständig gegen die aggressvsten Chemikalien. / El gres porcelánico no se mancha y es resistente a los agentes químicos más agresivos. / Даже самые агрессивные химикаты не повреждают керамогранит и не оставляют на нем пятен.

Résistant aux acides / Beständigkeit gegen Säuren / Resistente a los ácidos / Стойкость к кислотам

Résistant aux acides / Beständigkeit gegen Säuren / Resistente a los ácidos / Стойкость к кислотам

Le grès cérame résiste aux acides d'usage alimentaire et domestique. / Feinsteinzeug ist beständig gegen Säuren, die in Nahrungsmitteln oder im Haushalt verwendet werden. / El gres porcelánico es resistente a los ácidos de uso alimenticio y doméstico. / Керамогранит устойчив к кислотам, входящим в состав пищевых продуктов и средств бытовой химии.

Résistant aux écarts thermiques / Beständigkeit gegen thermoschocks / Resistente a los choques térmicos / Стойкость к перепадам температур

Résistant aux écarts thermiques / Beständigkeit gegen thermoschocks / Resistente a los choques térmicos / Стойкость к перепадам температур

Résistant à l'eau / Wasserfestigkeit / Resistente al agua / Стойкость к воде

Résistant à l'eau / Wasserfestigkeit / Resistente al agua / Стойкость к воде

Un sol en grès cérame ne subit aucune altération suite aux écarts thermiques. / Ein Feinsteinzeug-Fußboden wird von Temperaturschwankungen nicht beeinträchtigt. / El pavimento de gres porcelánico no cambia a causa de cambios bruscos de temperatura. / Напольные покрытия из керамогранита не разрушаются при перепадах температуры.

Résistant au gel / Frostbeständigkeit / Resistente a las heladas / Стойкость к морозам

Résistant au gel / Frostbeständigkeit / Resistente a las heladas / Стойкость к морозам

Le grès cérame est absolument non poreux et ne craint ni l'eau ni l'humidité. / Feinsteinzeug ist absolut porös und fürchtet weder Wasser noch Feuchtigkeit. / El gres porcelánico no es poroso, no le penetra el agua y es resistente a la humedad. / Керамогранит – абсолютно непористый материал, поэтому не боится воды и влаги.

Résistant au gel / Frostbeständigkeit / Resistente a las heladas / Стойкость к морозам

Résistant au gel / Frostbeständigkeit / Resistente a las heladas / Стойкость к морозам

Le grès cérame est ingélib et résiste aux températures les plus basses. / Feinsteinzeug ist frostbeständig und widersteht den niedrigsten Temperaturen. / El gres porcelánico es resistente a las heladas y a las bajas temperaturas. / Керамогранит способен противостоять морозам и низким температурам.

Santé / Gesundheit / Salud / Здоровье

Zéro allergène / Null allergene / Cero alérgenos / Ноль аллергенов

Zéro allergène / Null allergene / Cero alérgenos / Ноль аллергенов

Le grès cérame est inhospitalier vis-à-vis des acariens, bactéries, champignons, moisissures et autres substances irritantes. / Feinsteinzeug ist ungesund für Milben, Bakterien, Pilze, Schimmel und andere Reizstoffe. / El gres porcelánico es inhóspito para los ácaros, bacterias, hongos, mohos y otras sustancias irritantes. / На поверхности керамогранита не накапливаются клещи, бактерии, грибки, плесень и другие болезнетворные микроорганизмы.

Zéro COV / Null VOC / Cero VOC / Ноль летучих органических соединений

Zéro COV / Null VOC / Cero VOC / Ноль летучих органических соединений

Les carreaux en grès cérame sont intrinsèquement inorganiques et ne libèrent aucun composé organique volatil. / Feinsteinzeugfliesen sind von Natur aus anorganisch und setzen keine flüchtigen organischen Verbindungen frei. / Las baldosas de gres porcelánico son intrínsecamente inorgánicas y no emiten compuestos orgánicos volátiles. / Керамогранит является неорганическим материалом и не выделяет летучих органических соединений.

Zéro formaldéhyde / Null formaldehyd / Cero formaldehído / Ноль формальдегида

Zéro formaldéhyde / Null formaldehyd / Cero formaldehído / Ноль формальдегида

Le grès cérame ne contient pas de formaldéhyde. / Feinsteinzeug ist formaldehydfrei. / El gres porcelánico non contiene formaldehído. / Керамогранит не содержит формальдегид.

Zéro PVC / Null PVC / Cero PVC / Ноль ПВХ

Le grès cérame est privé de PVC, de matières plastiques et de dérivés du pétrole. / Feinsteinzeug ist frei von PVC, Kunststoffen oder Petroleumderivaten. / El gres porcelánico no contiene PVC, plástico o sustancias que derivan del petróleo. / Керамогранит не содержит ПВХ, пластиковых материалов, нефтепродуктов.

Prévention de la croissance bactérienne / Vorbeugung gegen das Wachstum von Bakterien / Previene la proliferación de bacterias / Предотвращение развития бактерий

Il prévient la croissance bactérienne / Vorbeugung gegen das Wachstum von Bakterien / Previene la proliferación de bacterias / Предотвращение развития бактерий

Le grès cérame est absolument hygiénique et inhospitalier vis-à-vis des bactéries, acariens, moisissures et champignons. / Feinsteinzeug ist absolut hygienisch und ungesund für Bakterien, Milben, Schimmel und Pilze. / El gres porcelánico es totalmente higiénico e inhóspito para las bacterias, ácaros, mohos y hongos. / Керамогранит абсолютно гигиеничен и препятствует развитию бактерий, клещей, плесени, грибка.

Sécurité / Sicherheit / Seguridad / Безопасность

Sécurité / Sicherheit / Seguridad / Безопасность

Sécurité / Sicherheit / Seguridad / Безопасность

Antiglisse / Rutschfestigkeit / Antideslizante / Препятствование скольжению

Antiglisse / Rutschfestigkeit / Antideslizante / Препятствование скольжению

Sécurité / Sicherheit / Seguridad / Безопасность

Les surfaces en grès cérame peuvent être réalisées avec un fond superficiel abrasif en mesure d'augmenter la traction et réduire le risque de glissade. / Die Oberflächen des Feinsteinzeugs können mit die Reibung erhöhenden Splitten bereichert werden, welche die Trittsicherheit verbessern und die Gefahr von Ausrutschern mindern. / Las superficies de gres porcelánico se fabrican con una granalla abrasiva superficial en grado de aumentar la tracción y reducir los riesgos de deslizamiento. / На поверхность керамогранитной плитки в процессе изготовления может наноситься специальная абразивная крошка, которая увеличивает сцепление и снижает риск скольжения.

Résistant au feu / Feuerfestigkeit / Resistente al fuego / Огнестойкость

Résistant au feu / Feuerfestigkeit / Resistente al fuego / Огнестойкость

Les carreaux en grès cérame sont ininflammables, ils réduisent la propagation de la flamme, ne brûlent pas et de libèrent aucune fumée toxique. / Feinsteinzfliesen sind nicht entflammbar, sie mindern die Flammenausbreitung, brennen nicht und setzen keinen toxischen Rauch frei. / Las baldosas de gres porcelánico no son inflamables, reducen la propagación de las llamas, son resistentes al fuego y no emiten humos tóxicos. / Керамогранитная плитка не воспламеняется, ограничивает распространение огня, не горит, не выделяет токсичного дыма.

Résistant à la chaleur / Wärmebeständigkeit / Resistente al calor / Термостойкость

Résistant à la chaleur / Wärmebeständigkeit / Resistente al calor / Термостойкость

Le grès ne subit aucune altération aux températures élevées. / Feinsteinzeug wird von hohen Temperaturen nicht verändert. / El gres porcelánico no se altera con las altas temperaturas. / Керамогранит не повреждается под действием высоких температур.

Environnement / Umwelt / Ambiente / Окружающая среда

Efficacité énergétique / Energieeffizienz / Eficiencia energética / Энергоэффективность

Efficacité énergétique / Energieeffizienz / Eficiencia energética / Энергоэффективность

La haute inertie thermique du grès cérame modère les écarts de température à l'intérieur des pièces, en favorisant ainsi les économies d'énergie. / Die hohe Wärmeträgheit des Feinsteinzeugs reduziert starke Temperaturschwankungen in den Räumen und ermöglicht demzufolge eine Energieeinsparung. / La elevada inercia térmica del gres porcelánico modera los cambios de temperatura de los ambientes, favoreciendo el ahorro energético. / Высокая тепловая инерция керамогранита сглаживает колебания температуры в помещениях, что позволяет значительно экономить энергию.

Écologique / Ökologisch / Ecológico / Экологичность

Écologique / Ökologisch / Ecológico / Экологичность

Le grès cérame a un faible impact sur l'environnement durant toutes les phases de son processus industriel, à partir des matières premières jusqu'à l'élimination et au recyclage. / In allen Phasen seines Herstellungsprozesses verursacht das Feinsteinzeug eine geringfügige Umweltbelastung, angefangen beim Abbau der Rohstoffe bis zur Entsorgung und zum Recycling. / El gres porcelánico tiene un bajo impacto ambiental en todas las fases de su proceso industrial, dese las materias primas hasta la eliminación y el reciclaje. / Керамогранит имеет низкое воздействие на окружающую среду на всем протяжении жизненного цикла: от добычи сырья до переработки и утилизации.

Recyclage et réutilisation / Recycling und wiederverwertung / Reciclaje y reutilización / Переработка и утилизация

Recyclage et réutilisation / Recycling und wiederverwertung / Reciclaje y reutilización / Переработка и утилизация

Le grès cérame est fabriqué avec des matériaux de recyclage, il dure longtemps en maintenant son aspect d'origine et il est recyclable. / Feinsteinzeug wird aus Recycling-Material hergestellt, hat eine lange Lebensdauer, erhält sein ursprüngliches Aussehen und kann recycelt werden. / El gres porcelánico está fabricado con materiales de reciclado, es duradero al paso del tiempo y se puede reciclar manteniendo el aspecto original. / Керамогранит изготавливается из переработанных материалов, долговечен, сохраняет во времени свои первоначальные характеристики и поддается переработке.

Idéal pour les systèmes de chauffage au sol / Ideal für fussbodenheizsysteme / Indicado para los sistemas de calefacción por suelo radiante / Идеальное решение для теплого пола

Idéal pour les systèmes de chauffage au sol / Ideal für fussbodenheizsysteme / Indicado para los sistemas de calefacción por suelo radiante / Идеальное решение для теплого пола

Le grès cérame peut être associé de manière efficace à des systèmes de chauffage au sol. / Feinsteinzeug ist optimal leistungsfähig in Verbindung mit Fußbodenheizsystemen. / El gres porcelánico se puede utilizar eficazmente con sistemas de calefacción por suelo radiante. / Керамогранит отлично подходит для облицовки полов с подогревом.

PROPRIÉTÉS DE LA CÉRAMIQUE POUR REVÊTEMENTS / EIGENSCHAFTEN DER WANDFLIESEN / CARACTERÍSTICAS Y BENEFICIOS DE LA CERÁMICA PARA REVESTIMIENTO / СВОЙСТВА КЕРАМИЧЕСКОЙ ПЛИТКИ

Tandis que le grès cérame est idéal pour l'usage au sol en raison de sa dureté et de son extrême résistance, les caractéristiques de légèreté et d'usinabilité des carreaux en pâte blanche en font l'idéal pour l'usage mural : les découpes et les perçages s'effectuent facilement et rapidement, en réduisant les temps et les coûts de la pose. / Während das Feinsteinzeug dank seiner Härte und extremen Widerstandsfähigkeit ideal für die Fußbodenverlegung ist, machen die Leichtheit und die Verarbeitungsfreundlichkeit der weißscherbigen Wandbeläge diese ideal für Wandverlegungen: Schnitte und Bohrungen werden leicht und schnell ausgeführt, wodurch die Verlegungszeiten und -kosten sich verringern. / Si bien el gres porcelánico es indicado para su uso en pavimentos, por su dureza y máxima resistencia, el revestimiento de pasta blanca es indicado para su uso en paredes por sus propiedades de ligereza y facilidad de trabajo: se consigue una mejor facilidad y rapidez de cortes y perforación, reduciendo los tiempos y costes de colocación. / Если керамогранит, в силу своей твердости и стойкости, особенно рекомендован для полов, то такие характеристики, как небольшой вес и высокая обрабатываемость, делают плитку из белой глины идеальной для монтажа на стену: легкость и быстрота резки и сверления снижают затраты времени и денег на укладку.

Facilité de travail / Verarbeitungsfreundlichkeit / Fácil de trabajar / Легкость обработки

Facilité de travail / Verarbeitungsfreundlichkeit / Fácil de trabajar / Легкость обработки

Nettoyage extrêmement facile / Extrem einfache Reinigung / Máxima facilidad de limpieza / Предельная простота ухода

Les découpes, les perçages et les biseautages sont faciles à réaliser et rendent plus rapide la pose des carrelages en pâte blanche. / Schnitte, Bohrungen, Abkantungen sind leicht zu verwirklichen, daher können weißscherbige Keramikbeläge überall schneller verlegt werden. / Cortes, perforaciones y biselados se realizan fácilmente y la instalación de los revestimientos de pasta blanca se hace con rapidez. / Легкость резки, сверления, скашивания граней ускоряет процесс укладки настенной плитки из белой глины.

Nettoyage extrêmement facile / Extrem einfache Reinigung / Máxima facilidad de limpieza / Предельная простота ухода

Nettoyage extrêmement facile / Extrem einfache Reinigung / Máxima facilidad de limpieza / Предельная простота ухода

Les carrelages céramiques en pâte blanche se nettoient simplement avec de l'eau chaude ou avec un détergent neutre. / Die weißscherbigen Keramikbeläge werden einfach durch Abwischen mit warmem Wasser oder einem neutralen Putzmittel gereinigt. / Los revestimientos cerámicos de pasta blanca se limpian pasando un trapo húmedo con agua caliente o detergente neutro. / Настенная плитка из белой глины очищается теплой водой или нейтральным моющим средством.

Green Project

Sustainability / Sostenibilità

In the environmental and economic sciences, sustainability is defined as the condition of development capable of ensuring the satisfaction of the needs of the present generation without compromising the ability of future generations to realize their own. Several international certifications guarantee that the Atlas Concorde products meet the criteria of sustainable construction, attesting to their low impact on the ecosystem, compliance with declared standards and attention to comfort.

Nelle scienze ambientali ed economiche, la sostenibilità è definita come condizione di uno sviluppo in grado di assicurare il soddisfacimento dei bisogni della generazione presente senza compromettere la possibilità delle generazioni future di realizzare i propri. Diverse certificazioni internazionali garantiscono che i prodotti Atlas Concorde rispondono ai criteri del costruire sostenibile, attestandone il basso impatto sull'ecosistema, la conformità agli standard dichiarati e l'attenzione al comfort abitativo.

Certifications / Certificazioni



ISO 9001

In 1995 Atlas Concorde obtained ISO 9001 quality certification for its products. It is an international recognition referring to the company's entire quality system, from the receipt of raw materials to their transformation, from the distribution of the product to their placement on the market.

Sin dal 1995 Atlas Concorde ha ottenuto per i propri prodotti la certificazione di qualità ISO 9001. Si tratta di un riconoscimento internazionale riferito all'intero sistema di qualità aziendale, dall'ingresso delle materie prime alla loro trasformazione, dalla distribuzione del prodotto alla sua immissione sul mercato.

LEED V4*

All Atlas Concorde porcelain floor and white body wall tiles can be used in projects that follow the guidelines of the GREEN BUILDING COUNCIL, which promotes the independent certification system LEED BD&C v4 (Leadership in Energy and Environmental Design, Building Design & Construction), whose parameters establish precise criteria for the design and construction of buildings that are healthy, energy efficient and with low environmental impact. All our products in porcelain stoneware and in white clay can therefore contribute to obtaining the LEED V4 rating of buildings, in relation to different areas: Sustainable Sites, Materials and Resources, Internal Environmental Quality.

Tutti i prodotti in gres porcellanato e in pasta bianca Atlas Concorde possono essere utilizzati in progetti che seguono le linee guida del GREEN BUILDING COUNCIL, che promuove il sistema di certificazione indipendente LEED BD&C v4 (Leadership in Energy and Environmental Design, Building Design & Construction), i cui parametri stabiliscono precisi criteri di progettazione e realizzazione di edifici salubri, energeticamente efficienti e a impatto ambientale contenuto. Tutti i nostri prodotti in gres porcellanato e in pasta bianca possono quindi contribuire all'ottenimento del rating LEED V4 degli edifici, relativamente a diverse aree tematiche: Siti Sostenibili, Materiali e Risorse, Qualità ambientale Interna.

EPD

Atlas Concorde also has an EPD declaration, which attests to the environmental sustainability of its products. The EPD (Environmental Product Declaration) also assesses the life cycle of a product, from extraction to production, transport, installation, maintenance, and cleaning. Atlas Concorde's EPD declaration was certified by the independent certifying body EPD ITALY.

Atlas Concorde dispone inoltre di una dichiarazione EPD, che attesta la sostenibilità ambientale dei prodotti. Anche la EPD (Environmental Product Declaration) valuta il ciclo di vita di un prodotto, dall'estrazione all'utilizzo passando per la produzione, il trasporto, l'installazione, la manutenzione e la pulizia. La dichiarazione EPD di Atlas Concorde è stata certificata dall'ente di certificazione indipendente EPD ITALY.

PEF*

The environmental footprint of products (PEF, Product Environmental Footprint, according to Recommendation 2013/179/EU) is a measurement that, based on various criteria, indicates the environmental performance of a product or service over its lifetime, taking into account supply chain activities: from the extraction of raw materials, to the production, use, and end of life of the product. Atlas Concorde has a verified PEF. Atlas Concorde's PEF was verified by the DNV-GL certifying body.

L'impronta ambientale dei prodotti (PEF, Product Environmental Footprint, secondo la Raccomandazione 2013/179/UE) è una misura che, sulla base di vari criteri, indica le prestazioni ambientali di un prodotto o servizio nel corso del proprio ciclo di vita, tenendo conto delle attività della catena di approvvigionamento: dall'estrazione di materie prime, alla produzione, all'uso e fine vita del prodotto. Atlas Concorde dispone di una PEF verificata. La PEF di Atlas Concorde è verificata dall'organismo di certificazione DNV-GL.

FDES*

Atlas Concorde has also drafted an FDES environmental declaration (Fiche de déclaration environnementale et sanitaire), this also having the purpose of transparently disclosing the product's impact, covering each phase from product extraction to production and finally laying and use.

Atlas Concorde ha realizzato inoltre la dichiarazione ambientale FDES (Fiche de déclaration environnementale et sanitaire), anch'essa con lo scopo di rendicontare in modo trasparente l'impatto del prodotto, a partire dalla fase di estrazione del prodotto, passando dalla fase di produzione, fino alla posa ed all'utilizzo.

HPD

Atlas Concorde has a HPD (Health Product Declaration) declaration, a complete report on the health characteristics of the finished product, compiled according to the HPD standard.

Atlas Concorde dispone della dichiarazione HPD (Health Product Declaration), un report completo sulle caratteristiche di salubrità del prodotto finito, compilato secondo lo standard HPD.

CAM/ISO 14021

An environmental declaration according to the ISO 14021 international standard, observance of Minimum Environmental Criteria, and the adoption of sustainability policies demonstrate Atlas Concorde's attention to environmental issues and allow the inclusion of its products in Green Public Tenders.

La dichiarazione ambientale secondo lo standard internazionale ISO 14021 ed il rispetto dei requisiti dei Criteri Ambientali Minimi permette ad Atlas Concorde, grazie all'adozione di politiche di sostenibilità, di dimostrare l'attenzione alle problematiche ambientali e proporre l'inserimento dei propri prodotti negli Appalti Pubblici Verdi.

For further details, please refer to / Per ulteriori dettagli, fare riferimento a: atlasconcorde.com



MADE IN ITALY. MADE TO EXCEL.

MADE IN ITALY

The Made in Italy logo of Atlas Concorde stands for style, quality and ethics. Having firmly adhered to the Ethical Code promoted by Confindustria Ceramica, Atlas Concorde places the Made in Italy logo on all the products designed and produced in Italy, that is to say ceramic tiles, decorations and the majority of special trim tiles. Only a small amount of the latter is manufactured in Spain. Atlas Concorde products are produced using eco-friendly technologies, top quality and safe raw materials with the best working conditions guaranteed for our personnel. For these reasons, Atlas Concorde's Made in Italy is the expression of strong values such as style, design, product quality, and respect for the environment and the people who live in it.

Il marchio Made in Italy di Atlas Concorde è sinonimo di stile, qualità ed etica. Avendo aderito con convinzione al Codice Etico di Confindustria Ceramica, Atlas Concorde appone il marchio Made in Italy su tutti i prodotti studiati, progettati e realizzati in Italia, nella fattispecie tutte le piastrelle di ceramica, le decorazioni e la maggioranza dei pezzi speciali. Solo un ristretto numero di questi ultimi è fabbricato in Spagna. I prodotti Atlas Concorde sono inoltre realizzati con tecnologie rispettose dell'ambiente, utilizzando materie prime eccellenti e sicure, garantendo le migliori condizioni di lavoro. Per queste ragioni il Made in Italy di Atlas Concorde è espressione di valori forti quali stile, design, qualità del prodotto, attenzione all'ambiente e alle persone.



The Ceramics of Italy logo is an exclusive identification on ceramic products which have effectively been made in Italy by companies that are a part of the Confindustria Ceramica and who adhered to its Ethical Code. This Code, promoted and created by Confindustria Ceramica, commits all companies to communicate, clearly and with transparency, the origin of their products.

Il marchio Ceramics of Italy contrassegna esclusivamente i prodotti ceramici effettivamente realizzati in Italia da un'azienda associata a Confindustria Ceramica che ha sottoscritto il Codice Etico. Il Codice, redatto dalla stessa Confindustria Ceramica, impegna a comunicare con chiarezza l'origine dei prodotti.

www.ceramica.info

CERAMICHE ATLAS CONCORDE S.p.A.
Via Canaletto 141
41042 Spezzano di Fiorano (MO) - Italia

ATLAS CONCORDE USA, Inc.
117 Seaboard Lane - Suite 170
Franklin, TN 37067 - USA

ATLAS CONCORDE RUSSIA
Business centre "Meliora Place"
Prospekt Mira 6, 129090 Moscow - Russia

atlasconcorde.com



Copyright 2021 by Ceramiche Atlas Concorde S.p.A.
(Spezzano di Fiorano, MO - Italy)
March 2021